



Inhalt

Über uns	02
Stühle_Sessel	10
Sofas	50
Betten	76
Zubehörteil	98
Technische Information	118

Über uns

EM Möbel Design ist Ihr Partner für umfassende Inneneinrichtungsdienstleistungen, sei es für Häuser, Wohnungen, Gastronomie, Hotels oder Restaurants. Unsere Erfahrung erstreckt sich über verschiedene Branchen, von Gastronomie bis zu Privatwohnungen, und wir legen großen Wert auf Nachhaltigkeit und Qualitätsstandards. Darüber hinaus bieten wir nicht nur Möbel, sondern auch eine umfassende Betreuung durch erfahrene Innenarchitekten. Von der individuellen Beratung über die kreative Projektentwicklung bis zur fachgerechten Montage vor Ort – unser engagiertes Team strebt danach, Ihre Vision von einzigartigen Innenräumen umzusetzen. Besuchen Sie unsere Ausstellungsräume oder nehmen Sie Kontakt auf, um mehr über unsere Dienstleistungen zu erfahren. EM Möbel Design – für Räume, die Ihre Persönlichkeit widerspiegeln und unsere Leidenschaft für exzellentes Design.

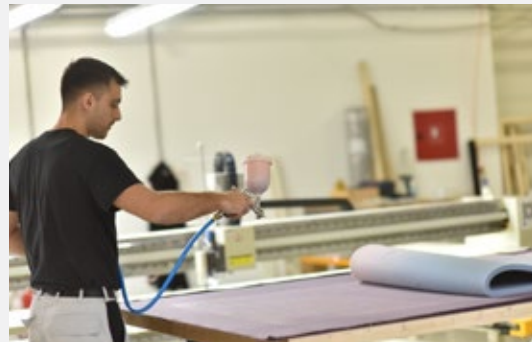

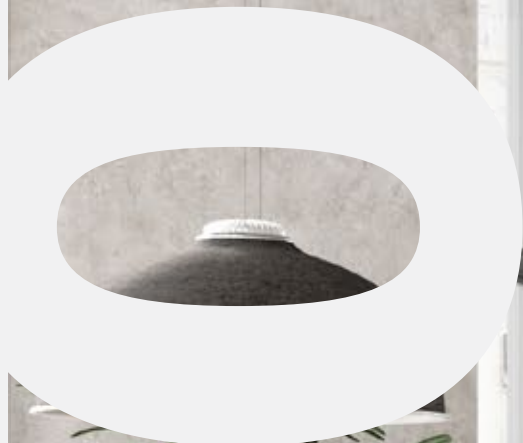

Meta

HR / Meta stolica lagana je i čvrsta, a njene tanke linije i oblici prate filozofiju „manje je više“. Jednostavna forma čini je idealnom za inspiraciju pri uređenju interijera.

ENG / Meta chair is lightweight and solid, with its thin lines and shapes following the “less is more” philosophy. Its simplicity of form makes it perfect as inspiration for the interior design.

DE / Der Stuhl Meta ist leicht und robust, und seine dünnen Linien und Formen folgen der Philosophie „Weniger ist mehr“. Seine einfache Form macht den Stuhl ideal als Inspiration für die Inneneinrichtung.

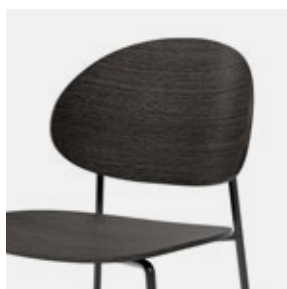
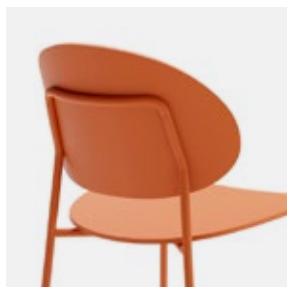

Meta wood

HR / Meta wood stolica je tapecirana verzija Meta stolice. Kombinacija udobnog, mekog sjedišta i drvene konstrukcije. Dostupna je u čak tri različite visine čime će odlično upotpuniti interijer restorana ili bara.

ENG / Meta wood chair is an upholstered model of Meta chair, a combination of comfortable, soft seat and a wooden frame. It is available in up to three different sizes in height, making it a perfect addition to the interior of a restaurant or bar.

DE / Der Stuhl Meta Wood ist eine gepolsterte Variante des Stuhls Meta, eine Kombination aus bequemer, weichen Sitzfläche und einer Holzkonstruktion. Es ist in bis zu vier verschiedenen Höhen erhältlich, die das Interieur eines Restaurants oder einer Bar perfekt abrunden.



Luna

HR / Luna stolica predstavlja spoj klasičnih čistih linija i udobnosti s modernim dizajnom. Dolazi u tri visine što daje mogućnost prilagodbe ovisno o prostoru i njegovu karakteru.

ENG / Luna chair is a combination of classic, sharp lines and of comfort with a modern design. It is available in three different sizes, allowing it to match your room and its character.

DE / Der Stuhl Luna ist eine Kombination aus klassischen klaren Linien und Komfort mit modernem Design. Er ist in drei Höhen erhältlich, was eine Anpassung an den Raum und seinen Charakter ermöglicht.



Lunar

HR / Uz zaobljen rukonaslon, Lunar daje osjećaj sigurnosti prilikom sjedenja, osobito ako se radi o modelu u tipu barske stolice. Zanimljiv dizajn unutarnje strane rukonaslona čini ju jednostavnom, ali efektnom.

ENG / Sporting a curved armrest, Lunar gives a sense of security while sitting, especially if the model is in the style of a bar stool. The inside of the armrests features attractive design which makes it look simple, yet effective.

DE / Mit einer abgerundeten Armlehne vermittelt Lunar ein sicheres Sitzgefühl, besonders wenn es sich um den Barhocker-Modell handelt. Das interessante Design der Innenseite der Armlehne macht diesen Stuhl einfach, aber effektiv.



Pasha

HR / Pasha stolica je lagana i udobna. Njezino meko sjedalo ima organsku formu koja, uz ljepotu oblika, ima i odličnu ergonomiju te će svako druženje na njima proći bez zamora. Pasha dolazi u tri visine pa se s lakoćom može kombinirati uz šankove, kuhinjske otoke i stolove.

ENG / Pasha chair is lightweight and comfy. Its soft seat features an organic shape, which, in addition to the beauty of the form, provides excellent ergonomics. This means that nobody has to worry about getting exhausted during those get-togethers that can last for hours. Pasha comes in three sizes, making it easy to integrate into bars, kitchen islands and tables.

DE / Der Stuhl Pasha ist leicht und bequem. Seine weiche Sitzfläche hat eine organische Form, die neben ihrer Schönheit auch eine hervorragende Ergonomie aufweist, und jede Geselligkeit ermüdungsfrei verlaufen lässt. Pasha gibt es in drei Höhen, sodass es sich gut mit Bars, Kücheninseln und Tischen kombinieren lässt.





Miraz

HR / Miraz stolica je udobna, atraktivna i lagana. U svakoj od dostupnih boja tkanina, odlična je za osvježavanje prostora.

ENG / Miraz chair is comfy, stylish and lightweight. Available in every fabric color, it is perfect for sprucing up the room.

DE / Der Stuhl Miraz ist bequem, attraktiv und leicht. In jeder der verfügbaren Stofffarben eignet er sich hervorragend, um den Raum aufzufrischen.



Uno

HR / Uno stolicu/polunaslonjač karakteriziraju skladne linije koje su čvrsto definirane, a u isto vrijeme mekane i zaobljene. Ergonomski je iznimno udoban i za duže sjedenje. Jastučić na naslonu ugodno podupire leđa, a rukonasloni koji se blago spuštaju prema naprijed, omogućuju opušteno sjedenje.

ENG / Uno chair / armchair features smooth lines which are firmly defined and simultaneously soft and curved. In terms of ergonomics, it is extremely comfortable for prolonged sitting. The backrest padding provides a comfortable support for your back, while armrests, slightly lowered forward, provide a relaxing sitting position.

DE / Der Stuhl/Halbsessel Uno zeichnet sich durch harmonische Linien, die fest definiert und gleichzeitig weich und abgerundet sind, aus. Ergonomisch ist er für längeres Sitzen äußerst bequem. Das Polster der Rückenlehne stützt bequem den Rücken und die leicht nach vorne abgesenkten Armlehnen ermöglichen ein entspanntes Sitzen.





Uno Aria

HR / Uno Aria primjer je spoja modernog i udobnog. Rukonasloni blago zakrivljeni prema dolje pomažu u opuštenijem sjedenju. Dizajn koji će se izvrsno uklopiti u uredski prostor ili lobby.

ENG / Uno Aria is an example of combining contemporary style and comfort. The slightly curved armrests are designed for more relaxed sitting. A design which will blend perfectly into any office or a lobby.

DE / Uno Aria ist ein Beispiel für eine Kombination aus Moderne und Komfort. Die leicht nach unten gebogenen Armlehnen helfen beim entspannteren Sitzen. Dies ist ein Design, das perfekt in einen Büroraum oder eine Empfangshalle passt.

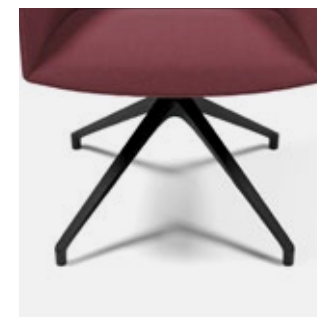



Bloom

HR / Bloom stolica, kao što i sam naziv govori, razigranim dizajnom rukonaslona podsjeća na latice cvjetova. Uz udoban naslon, ima i bogato tapecirani dio sjedišta koji omogućuje neometano duže sjedenje.

ENG / Bloom chair, as its name suggests, features a playful armrest design reminiscent of flower petals. In addition to its comfortable backrest, the chair also features a richly upholstered seat which allows for uninterrupted prolonged sitting.

DE / Der Stuhl Bloom hat, wie der Name schon sagt, ein verspieltes Armlehndesign, das an Blütenblätter erinnert. Neben der bequemen Rückenlehne verfügt er auch über einen reich gepolsterte Sitzfläche, die ungestörtes längeres Sitzen ermöglicht.



Lane

HR / Lane moderni i bezvremenski klasik, uklopit će se svojim jednostavnim linijama u svaku priču. Moguć je odabir između dvije baze od čega svaka nosi svoj karakter i dinamiku.

ENG / With its clean lines, Lane is a modern and timeless classic that can fit into any story. You can choose between two bases, each with its own unique character and vibe.

DE / Lane ist ein moderner und zeitloser Klassiker, der mit seinen schlichten Linien in jedes Konzept passt. Es kann zwischen zwei Untergestellen gewählt werden, von denen jeder seinen eigenen Charakter und Dynamik aufweist.





Laner

HR / Laner stolica prati liniju stolica Lane, ali s dodatkom rukonaslona. Laner je time zapravo postao polunaslonjač dodatne udobnosti i visoke elegancije.

ENG / Laner chair closely resembles the line of Lane chairs, but with added armrests. As a result, Laner has actually become an armchair with extra comfort and refined elegance.

DE / Der Stuhl Laner folgt den Linien des Stuhls Lane, jedoch mit dem Zusatz von Armlehnen. Damit wird Laner eigentlich ein Halbsessel für zusätzlichen Komfort und hohe Eleganz.



Rita / R

HR / Rita stolica je naša "moderna klasika". Uz ravne linije i plohe ne nedostaje osjećaj raskoši i udobnosti. Noge od punog drveta dodatno doprinose dojmu topline i kvalitete. Rita će se svojim dizajnom uklopiti u mnoge interijere.

ENG / Rita chair is our "modern classic." Featuring straight lines and surfaces, the feeling of luxury and comfort will not go unnoticed. Legs of solid wood further enhance the sense of both warmth and quality. The charming design of Rita chair will fit into many interiors.

DE / Der Stuhl Rita ist unser „moderner Klassiker“. Die geraden Linien und Flächen sorgen für viel Luxus und Komfort. Die Beine aus Massivholz tragen zusätzlich zum Eindruck von Wärme und Qualität bei. Mit seinem Design passt der Stuhl Rita in viele Innenräume.



UN OO





Alison

HR / Alison stolica na nogama od punog drveta udobno je sjedalo jednostavne forme, bogato tapecirano udobnom spužvom. Njezin izgled i materijali daju toplinu i šarm svakom interijeru.

ENG / Resting on solid wood legs, Alison chair features a comfortable, simple seat, with rich upholstery and a comfortable foam. Its appearance and materials add a sense of warmth and charm to any interior.

DE / Mit seinen Massivholzbeinen ist der Stuhl Alison ein komfortabler Sitzmöbelstück von einfacher Form, und mit einem bequemen Schwamm reich gepolstert. Sein Optik und seine Materialien verleihen jedem Innenraum Wärme und Charme.

40



Sail

HR / Sail stolica svojim profinjenim izgledom decentno će upotpuniti interijer restorana ili hotelske sobe. Lako bi mogla postati i glavna zvijezda interijera ako se nade u blagovaonici. Zaobljenost sjedišta i naslona udobno pridržavaju tijelo u različitim položajima sjedenja.

ENG / With its refined look, Sail chair will subtly complement the interior of any restaurant or a hotel room. In fact, if it finds its place in the dining room, it could easily become its centerpiece. The seat and the backrest are curved, thus comfortably supporting the body in different sitting positions.

DE / Mit seinem raffinierten Aussehen wird der Stuhl Sail das Interieur eines Restaurants oder Hotelzimmers dezent vervollständigen. Er könnte auch leicht zum Hauptstar des Interieurs werden, wenn es im Esszimmer platziert wird. Die abgerundete Form der Sitzfläche und Rückenlehne halten den Körper bequem in verschiedenen Sitzpositionen.



Duo / R

HR / Duo polunaslonjač ima univerzalan vizualni karakter, definiran jednostavnim i pročišćenim linijama koje se uklapaju u interijere klasičnog, ali i modernog stila. U verziji s rukonaslonom, udobnost sjedenja prelazi na višu razinu.

ENG / Duo armchair features a universal visual nature, defined by its simple and refined lines that will fit into both classic and contemporary interiors. The armrest model takes the seat comfort to a whole new level.

DE / Der Halbsessel Duo weist einen universellen visuellen Charakter auf, der durch einfache und raffinierte Linien definiert ist, die in die Innenräume des klassischen und modernen Stils gut passen. In der Version mit Armlehnen wird der Sitzkomfort auf ein höheres Niveau gehoben.



Prizma

HR / Prizma stolica provjerenog i dopadljivog dizajna, upotpunit će interijer restorana, bara ili blagovaonice. Konstrukcija sjedišta i ispunjena jastuka, koji se može skidati, osiguravaju maksimalnu udobnost koja će omogućiti sate razgovora u dobrom društvu bez narušavanja udobnosti.

ENG / The trusted and appealing design of Prizma chairs will complement the interior of any restaurant, bar or dining room. Designed for maximum comfort, the seat and removable cushion padding allow for hours of socializing without sacrificing comfort.

DE / Mit einem bewährten und ansprechenden Design vervollständigt der Stuhl Prizma die Einrichtung jedes Restaurants, jeder Bar oder jedes Esszimmers. Die Konstruktion der Sitzfläche und die abnehmbare Kissenpolsterung sorgen für maximalen Komfort, der stundenlange Gespräche in guter Gesellschaft ermöglicht, ohne den Komfort zu beeinträchtigen.





Indie

HR / Indie je, svojim zaobljenim dizajnom rukonaslona, savršena stolica za opuštanje. Odlična za čitanje najdraže knjige u trenucima kada je sve ostalo manje bitno.

ENG / A curved armrest design makes Indie the perfect chair to relax in. It is perfect for reading your favorite book during those moments when everything else seems less important.

DE / Mit seinem abgerundeten Armlehndesign ist Indie der perfekte Stuhl zum Entspannen. Großartig zum Lesen Ihres Lieblingsbuchs in Momenten, wenn alles andere weniger wichtig ist.





20

Fozy

HR / Fozy dvosjed i fotelja šarmantan su komplet. Uz visoku dekorativnu vrijednost, nudi i iznenađujuće udobno sjedenje zahvaljujući kombinaciji opružnog sustava i spužvaste ispune. Podsjeća nas na dvosjede zaboravljene u djetinjstvu na kojima smo kao mali sjedili kod bake.

ENG / Fozy two-seater and armchair make a charming set providing a surprisingly comfortable seat as well as a great decorative appeal, a result of combining a spring system with the foam padding. It is reminiscent of our childhood and the forgotten two-seaters that our grandmas used to have.

DE / Die Zweisitzer-Sofa und der Sessel Fozy sind ein charmantes Set, das neben einem hohen dekorativen Wert auch ein überraschend bequemes Sitzen, dank einer Kombination aus einem Federsystem und einer Schwammfüllung, bietet. Das Zweisitzer-Sofa erinnert uns an in der Kindheit vergessene Sofas, auf denen wir als Kinder bei unserer Großmutter gesessen haben.





Frame

HR / Frame dvosjed i fotelja lagane su i čvrste konstrukcije zbog čega se s lakoćom premještaju po prostoru. Iako modernih i elegantnih linija, ovaj set omogućava udobno sjedenje što njegovu funkcionalnost podiže na novi nivo.

ENG / Frame two-seater and armchair feature a lightweight and solid design that makes it easy to move around. But despite its modern and elegant lines, it still provides comfortable seating, taking its functionality to a whole new level.

DE / Das Zweisitzer-Sofa und der Sessel Frame haben eine leichte und solide Konstruktion, die es einfach macht, sie mühelos durch den Raum zu bewegen. Trotz moderner und eleganter Linienführung bietet dieses Set bequeme Sitzgelegenheiten, was seine Funktionalität auf ein neues Niveau hebt.





Cubic

HR / Cubic sofa je odgovor na svaku potrebu za modularnosti. Različite elemente moguće je rasporediti prema vlastitim preferencijama te na takav način iskoristiti maksimalno prostor u kojem se nalazi.

ENG / Cubic sofa responds to every need for modularity. You can arrange different elements according to your very own liking, thus maximizing the use of the room they are in.

DE / Das Sofa ist die Antwort auf alle Bedürfnisse nach Modularität. Die verschiedenen Elemente können nach persönlichen Vorlieben angeordnet werden, was es ermöglicht den Raum, in dem sie sich befinden, optimal zu nutzen.

56



Regular

HR / Regular dvosjed i fotelja stvoreni su kako bi pružili maksimalnu udobnost. Oblikom skladno odmjereni i nenametljivi, ovi komadi postaju dio svakodnevnice i nezamjenjivo mjesto okupljanja i opuštanja. Svojim dimenzijama optimalno će se smjestiti u većinu današnjih dnevnih soba.

ENG / Regular two-seaters and armchair are designed to provide maximum comfort. Perfectly balanced and subtle, these pieces will become a part of everyday life and an irreplaceable place to meet and relax. Given its dimensions, it will fit perfectly into most contemporary living rooms.

DE / Das Zweisitzer-Sofa und der Sessel Regular sind so konzipiert, dass sie maximalen Komfort bieten. Harmonisch ausbalanciert und unaufdringlich in ihrer Form, werden diese Stücke zu einem Teil des Alltags und zu einem unersetzlichen Treffpunkt und Entspannungsecke. Mit seinen Maßen passt er optimal in die meisten heutigen Wohnzimmer.

58



Softa

HR / Softa sustav za sjedenje razvijen je bez kompromisa. Njegove zaobljene i skladne linije stvorene su za suvremene interijere koji odišu minimalizmom i profinjenošću. Korištene su samo najbolje tkanine te vrhunsko punjenje za najudobnije sjedenje. Kombinacijom njegovih elemenata slaže se optimalna veličina i oblik garniture.

ENG / We designed the Softa seating system with no compromises. Its curved and smooth lines are perfect for modern interiors evoking minimalism and sophistication. It is made with only the best fabrics and the highest quality padding for the most comfortable seating. A combination of its elements agrees with the optimal size and shape of the set.

DE / Das Sitzsystem Softa wurde kompromisslos entwickelt. Seine abgerundeten und harmonischen Linien sind für moderne Innenräume geschaffen, die Minimalismus und Raffinesse ausstrahlen. Für die bequemsten Sitzgelegenheiten wurden nur die besten Stoffe und die hochwertigsten Füllungen verwendet. Durch die Kombination seiner Elemente kann ein Möbel-Set optimaler Größe und Form zusammengestellt werden.





Stretch

HR / Stretch sustav za sjedenje stvoren je za osjećaj vrhunske udobnosti. Na njemu možete sjediti, ležati, a stolić koristiti za grickalice uz gledanje filma ili druženje s prijateljima.

ENG / Stretch seating system made for an ultimate comfort experience. It is possible to sit on it, to lounge on it, in fact, you can grab snacks or a drink off its table while watching a movie or hanging out with friends.

DE / Das Sitzsystem Stretch wurde für ein Gefühl von ultimativem Komfort geschaffen. Sie können auf ihm sitzen, sich hinlegen, und von dem Tisch können Sie Snacks oder ein Getränk genießen, während Sie einen Film ansehen oder mit Freunden abhängen.



Paris

HR / Paris sofa kao idealan komad namještaja za vaš životni prostor. Razne mogućnosti kombiniranja njenih elemenata čine ju dinamičnom, a za dodatno opuštanje i mjesto više, tu je i tabure.

ENG / Paris sofa as the perfect piece of furniture for your living space. Versatile options for combining its elements make it dynamic, with the option of adding ottomans for additional relaxation and more space.

DE / Das Sofa Paris als ideales Möbelstück für Ihren Wohnraum. Vielfältige Kombinationsmöglichkeiten seiner Elemente machen es dynamisch, und für zusätzliche Entspannung und mehr Platz gibt es auch ein Hocker.







Roma

HR / Niz praktičnih varijanti sofe Roma ostavlja dovoljno prostora da je uz odabir tkanine uklopite u svoju svakodnevicu i omogućite si trenutke u kojima ćete u potpunosti iskoristiti njegovu udobnost.

ENG / Available in several practical options, the Roma sofa leaves you with enough room to incorporate it into your everyday life by choosing the fabric, so you can enjoy moments that will allow you to take the most of its comfort.

DE / Praktische Varianten des Roma Sofas lassen genug Spielraum, um ihn durch die Stoffwahl in Ihren Alltag einzufügen und sich Momente zu gönnen, in denen Sie seinen Komfort voll ausschöpfen werden.

Valencia

HR / Udobna sofa Valencia podići će funkcionalnost dnevnog boravka na novu razinu i omogućiti nezaboravna druženja, a varijanta na razvlačenje izrazito je korisna u iznenadnim situacijama.

ENG / This comfortable sofa will take the functionality of the living room to a whole new level, allowing unforgettable get-togethers, while the pullout sofa will be extremely useful in unexpected situations.

DE / Das bequeme Sofa Valencia wird die Funktionalität des Wohnzimmers auf ein neues Niveau heben und unvergessliche Geselligkeit ermöglichen. Die ausziehbare Variante ist in ungeplanten Situationen äußerst nützlich.



Manhattan

HR / Klasika s kojim ne možete pogriješiti. Manhattanu odlično pristaje svaka boja tkanine i s lakoćom će se uklopiti u svaki dnevni boravak.

ENG / It is a classic you can't go wrong with. Manhattan matches perfectly with any fabric color and blends easily into any living room.

DE / Ein Klassiker, der immer gut ankommt. Dem Sofa Manhattan passt jede Stofffarbe hervorragend und es passt problemlos in jedes Wohnzimmer.

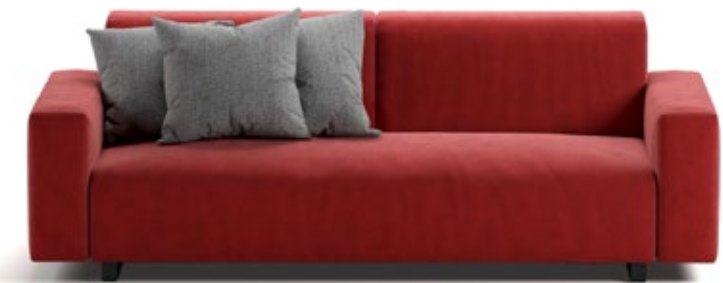





Domino

HR / Knjiga, časopis ili tablet, uzglavlje Domino kreveta iskoristivo je za sve stvari koje bismo voljeli naći pri ruci jednom kada našoj večeri dođe kraj. Uz udobnost i toplinu, što vam više treba?

ENG / The headboard of Domino bed is useful for all the things we like to have at hand at the end of the evening, be it a book, a magazine or a tablet. Along with comfort and warmth, what more could you ask for?

DE / Ob Buch, Zeitschrift oder Tablet, das Kopfteil des Domino-Bettes eignet sich für all die Dinge, die wir am Ende des Abends gerne zur Hand hätten. Was braucht man außer Komfort und Wärme mehr?



Linea

HR / Linea krevet je dizajniran tako da zadržava svoju estetiku i prepoznatljivost u sve četiri ponudene varijante širine. Nešto drugačije uzglavlje, s naborima, djeluje elegantno, dok ugrađena rasvjeta s USB utičnicom nadohvat ruke podiže funkcionalnost kreveta na novu razinu.

ENG / Linea bed is designed to retain its aesthetics and uniqueness in all four available width options. The folded headboard looks very elegant, while the built-in lighting with USB connection, which is just within your reach, takes the bed functionality to a whole new level.

DE / Das Bett Linea ist so konzipiert, dass es seine Ästhetik und Wiedererkennbarkeit in allen vier angebotenen Breitenvarianten behält. Das etwas andere Kopfteil mit Falten sieht elegant aus, während die eingebaute Beleuchtung mit USB-Anschluss auf Knopfdruck die Funktionalität Ihres Bettes auf ein neues Niveau hebt.





Leaf

HR / Leaf krevet ima udobne obline uzglavlja koje će vam pomoći da se opustite i svoj dan započnete na najbolji mogući način. Njegov moderan dizajn učinit će ga glavnom inspiracijom za uređenje ostatka prostorije.

ENG / Leaf bed features comfortable curved headboards so you can relax and start your day in the best way possible. Its contemporary design will turn it into the main inspiration when decorating the rest of the room.

DE / Die bequemen Kurven des Kopfteils des Betts Leaf helfen Ihnen, sich zu entspannen und Ihren Tag optimal zu beginnen. Sein modernes Design wird es zur Hauptinspiration für die Dekoration des restlichen Raums machen.



4



Ares

HR / Kvalitetan san poboljšava kvalitetu našeg života, a krevet Ares fantastično je rješenje po tom pitanju. Interijer spavaće sobe je prvo što ugledamo svaki dan pa je i lijep dizajn svakako važan za naše raspoloženje.

ENG / A good night's sleep improves the quality of our lives, and Ares bed delivers just that. Our bedroom aesthetic is the first thing we see each morning, which is why we can say that beautiful interior certainly impacts our mood.

DE / Guter Schlaf verbessert unsere Lebensqualität, und das Bett Ares ist eine fantastische Lösung dafür. Die Einrichtung des Schlafzimmers ist das erste, was wir jeden Tag sehen, daher ist ein schönes Design sicherlich wichtig für unsere Stimmung.





Virgo

HR / Virgo uzrokuje čežnju za krevetom toliko da će lijena jutra u krevetu biti još udobnija. Dodatno začiniti svoje snove možete i odabirom tkanine po svom izboru.

ENG / Virgo instills such yearning for bed making those lazy mornings in bed even more enjoyable. Add some extra spice to your dreams by choosing the fabric of your choice.

DE / Das Bett Virgo weckt so große Sehnsucht nach dem Bett, dass ein fauler Morgen im Bett noch gemütlicher wird. Sie können Ihre Träume zusätzlich aufpeppen, indem Sie den Stoff Ihrer Wahl auswählen.



Stretchbed

HR / Stretch krevet uz svoju udobnost i atraktivan dizajn pomaže u spremanju svih onih malih stvari koje preko tjedna završe na noćnom ormariću.

ENG / Fitted with comfort and appealing design, Stretch bed can help store all those small items that end up on the bedside table throughout the week.

DE / Mit seinem Komfort und attraktiven Design hilft das Bett Stretch dabei, all die kleinen Dinge zu verstauen, die während der Woche auf dem Nachttisch landen.



92



Cozy

HR / Ovaj izuzetno moderan dizajn kreveta Cozy udobno će se smjestiti u vaš privatni prostor baš kao i u hotelskoj sobi. Veliki jastuci na prvi pogled zrače udobnošću i jednostavno vas pozivaju na počinak.

ENG / This ultra modern design of Cozy bed blends nicely into your private space, just as it would in a hotel room. At first glance, the large pillows give off a sense of coziness and simply invite you to rest.

DE / Das äußerst moderne Design des Betts Cozy fügt sich bequem in Ihren privaten Bereich ein, genau wie in ein Hotelzimmer. Die großen Kissen strahlen auf den ersten Blick Gemütlichkeit aus und laden einfach zum Ausruhen ein.





Linea Art

HR / Linea Art, krevet s podiznom podnicom, omogućava vam dodatno spremište koje možete iskoristiti prema svojoj želji. Odlično rješenje za manje životne prostore.

ENG / Linea Art ottoman bed adds an extra storage space, which can be used as desired. A great solution for smaller living spaces.

DE / Das Bett Linea Art mit Hubboden bietet Ihnen zusätzlichen Stauraum, den Sie nach Belieben nutzen können. Tolle Lösung für kleinere Wohnräume.





Life.*

*Available for a limited time only. Limit one (1) per person. Subject to change without notice. Includes "up to" and without any restrictions. Not transferable and is the sole responsibility of the recipient. May incur damages arising from use or misuse. Additional terms and conditions apply. Your mileage may vary. Subject to all applicable laws and regulations. Terms and conditions apply. Other restrictions apply.

Oval

HR / Moderan i minimalistički izgled stolića Oval savršeno će se uklopiti u bilo koju kompoziciju interijera što ostavlja dovoljno prostora za daljnje uređivanje.

ENG / With its modern and minimalist look, the Oval coffee table harmonizes perfectly with any interior and still offers plenty of space for additional decoration.

DE / Der moderne und minimalistische Look des Kaffeetisches Oval fügt sich perfekt in jeden Innenraum ein und lässt genügend Platz für weitere Einrichtung.



M
R
O

Meshroom

HR / Dinamični Meshroom stolići odlični su za popunjavanje prostora i odlaganje svega što vam upotpunjava dan, kao što je prva jutarnja kava.

ENG / The vibrant Meshroom tables are a great way to fill the space and store whatever you need to complete your day, such as your first morning coffee.

DE / Die dynamischen Kaffeetische Meshroom eignen sich hervorragend, um den Raum zu füllen und alles zu aufzustellen, was Ihren Tag vervollständigt, wie der erste Morgenkaffee.



Poker

HR / Praktičan stol uz kojeg nudimo i taburee koji savršeno stanu ispod stola. Zaigrajte svoju omiljenu igru uz dobro društvo i vidjet ćete različit raspon emocija oko njega.

ENG / This is a very practical table, also accompanied by ottomans that fit perfectly under it. Play your favorite game with your friends, and you'll witness a different emotional palette around it.

DE / Ein praktischer Tisch, den Sie auch mit Hockern bekommen können, die perfekt unter den Tisch passen. Spielen Sie Ihr Lieblingsspiel in guter Gesellschaft und Sie werden eine andere Palette von Emotionen um ihn erleben.



Bassic

HR / Jednostavnog imena i betonske baze Basic je stolić na kojega se možete osloniti. Dolazi u tri visine i tri promjera.

ENG / With its simple name and concrete base, Basic truly is a table you can rely on. It is available in three different sizes and three diameters.

DE / Mit einem einfachen Namen und einem Tischfuß aus Beton ist Basic ein Kaffeetisch, auf den Sie sich verlassen können. Er ist in drei Höhen und drei Durchmessern erhältlich.



Mila

HR / Igrom boja i uštedom na prostoru, Mila je idealno rješenje za manje prostore koji su fokusirani na jednostavnost i funkcionalnost.

ENG / Thanks to its rich palette of colors and its space saving features, Mila is the perfect solution for smaller spaces focused on simplicity and functionality.

DE / Mit seinem Farbspiel und Platzersparnis ist der Kaffeetisch Mila die ideale Lösung für kleinere Räume, die auf Einfachheit und Funktionalität ausgerichtet sind.



Quadro

HR / Odličan u prilagodbi manjim i većim društvima. Za ovaj stol svi su pozvani.

ENG / Excellently suited for smaller and larger group of people. All are welcome to sit at this table.

DE / Ideal für die Anpassung an kleinere und größere Versammlungen. Jeder ist zu diesem Tisch eingeladen.



Pascale

HR / Pascale stolići idealni su za veće i manje prostore u koje želite unijeti pročišćene linije i elegantan dizajn koji će zbog kvalitete izrade potrajati godinama.

ENG / Pascale tables are ideal for larger and smaller spaces where you are looking to introduce refined lines and an elegant design that will last for years due to its quality.

DE / Die Kaffeetische Pascale sind ideal für größere und kleinere Räume, in denen Sie raffinierte Linien und ein elegantes Design bringen möchten. Aufgrund der Herstellungsqualität werden sie viele Jahre dauern.



Teka / Ø

HR / Krug i kvadrat su oblici koji se pojavljuju u mnogim slagalicama i igrama. Teka drveni stolčići pozivaju da ih slažete i poigrate se s njima.

ENG / A circle and a square, shapes that appear in many puzzles and games. Teka wooden tables invite you to stack them and play with them.

DE / Der Kreis und das Quadrat sind Formen, die in vielen Puzzles und Spielen vorkommen. Die Holzkaffeetische Teka laden zum Zusammenlegen und Spielen ein.



Island

HR / S odabirom stolčića Island nećete pogriješiti, odličan je za odlaganje kave u mirna zimska jutra. Toplina drveta i hladnoća metalnog dijela stolčića isprepliće se kroz dizajn i prilagođava se ostalim elementima vašeg interijera.

ENG / You will not make a mistake by choosing the Island table. Perfect for cold winter mornings when you need a place to set your coffee. The warmth from the wood and the cold from the metal part of the table intertwined together form a design that easily adapts to the other elements of your interior.

DE / Der Kaffeetisch Island ist die richtige Wahl. Er eignet sich hervorragend zum Kaffee trinken an ruhigen Wintermorgen. Die Wärme des Holzes und die Kühle des Metallteils des Kaffeetisches werden durch das Design miteinander verflochten und passen sich anderen Elementen Ihres Interieurs an.



Unotab

HR / Unotab stolici svojom jednostavnošću uklapaju se i u minimalističke, ali i interijere koji ne štede s detaljima. Opremite se ovim „modernim klasikom“ i uživajte u druženjima, ispijanju kava nakon napornog dana i ostalim aktivnostima koje vas vesele.

ENG / Unotab tables fit in with their simplicity both in minimalist, but also into interiors that do not skimp on the details. Equip yourself with this “modern classic” and enjoy socializing, drinking coffee after a hard day and any other activity that may make you happy.

DE / Die Kaffeetische Unotab passen mit ihrer Schlichtheit in minimalistische Innenräume, aber auch in Interieurs, die nicht an Details sparen. Statten Sie Ihren Raum mit diesem „modernen Klassiker“ aus und genießen Sie Geselligkeit, Kaffeetrinken nach einem anstrengenden Tag und andere Aktivitäten, die Ihnen Freude machen.



Aruba

HR / Šesterokutni taburei koji vam dozvoljavaju kombiniranje oblika praktični su i prilagodljivi. Mekano i udobno rješenje za vaš pažljivo birani prostor.

ENG / Hexagonal ottomans that allow you to combine shapes and are also practical and adaptable. A soft and comfortable solution for your carefully chosen space.

DE / Diese sechseckige Hocker, die es Ihnen ermöglichen, verschiedene Formen zu kombinieren, sind praktisch und anpassbar. Eine weiche und bequeme Lösung für Ihren sorgfältig gestalteten Raum.



Capri / Ø

HR / Jednostavnost Capri taburea čini ga podobnim za uklapanje u prostore neovisno o smjeru u kojem dizajn ide.

ENG / The simplicity of the Capri ottoman makes it eligible for fitting into spaces regardless of the design.

DE / Die Schlichtheit des Hockers Capri macht ihn für die Einpassung in verschiedene Räume geeignet, unabhängig von der von Ihnen gewählten Designrichtung.



Isla

HR / Prave i čiste linije ovog taburea uklopit će se u vaš životni prostor i učiniti ga funkcionalnim. Osim što je sam po sebi poseban, izuzetno je praktičan.

ENG / The straight and clean lines of this ottoman will fit into your living space easily and make it functional. Apart from being special, it is extremely practical.

DE / Die geraden und klaren Linien dieses Hockers passen gut in Ihren Wohnraum und machen ihn funktional. Abgesehen davon, dass er an sich etwas Besonderes ist, ist er auch äußerst praktisch.



Martin

HR / Dolazi u dvije dimenzije i dozvoljava vam kreativnost u slaganju zanimljivih formi, a na vama je da odaberete svoje najdraže boje.

ENG / Coming in two dimensions, it allows creative outbursts in arranging interesting shapes. It is up to you to choose your favorite color.

DE / Er ist in zwei Dimensionen erhältlich und ermöglicht Ihnen Kreativität beim Zusammenstellen interessanter Formen. An Ihnen ist es, Ihre Lieblingsfarben zu wählen.



Dali

HR / Nesvakidašnjeg oblika i tkanine daje posebnu notu svakom interijeru koji je spreman za odvažne kombinacije.

ENG / Unusual shape and fabric give a special touch to any interior that is ready for bold combinations.

DE / Ungewöhnliche Form und Stoff verleihen jedem Interieur, das für mutige Kombinationen bereit ist, eine besondere Note.



FILE

Meta

SJEDIŠTE I NASLON - furnir/HR spužva
 POSTOLJE - metal
 PRESVLAKA - tkanina
 SEAT & BACKREST - veneer/HR foam
 BASE - metal
 UPHOLSTERY - fabric
 SITZ UND RÜCKENLEHNE - Furnier/HR-Schaum
 GESTELL - Metall
 BEZUG - Stoff

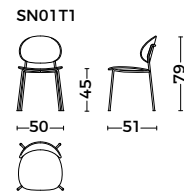

Metawood

SJEDIŠTE I NASLON - furnir/HR spužva
 POSTOLJE - masiv
 PRESVLAKA - tkanina
 BARSKA STOLICA - metalni obruč
 BACKREST - veneer/HR foam
 BASE - solid wood
 UPHOLSTERY - fabric
 BAR STOOL - metal hoop
 SITZ UND RÜCKENLEHNE - Furnier/HR-Schaum
 GESTELL - Massivholz
 BEZUG - Stoff
 BAR STOOL - Metallreif

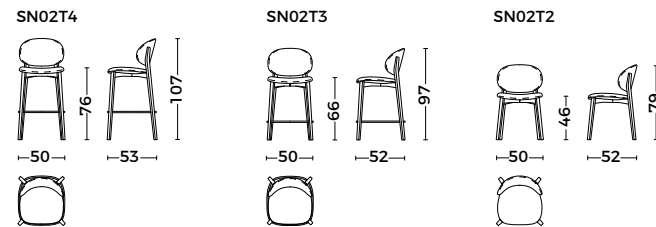

Luna

ŠKOLJKA - lijevana pjena
 POSTOLJE - metal
 PRESVLAKA - tkanina
 SHELL - moulded foam
 BASE - metal
 UPHOLSTERY - fabric
 SCHALE - Gießschaum
 GESTELL - Metall
 BEZUG - Stoff

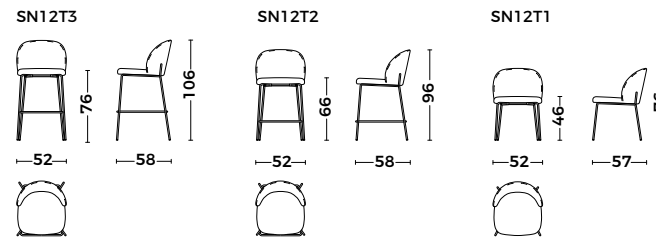

Lunar

ŠKOLJKA - lijevana pjena
 POSTOLJE - metal
 PRESVLAKA - tkanina
 SHELL - moulded foam
 BASE - metal
 UPHOLSTERY - fabric
 SCHALE - Gießschaum
 GESTELL - Metall
 BEZUG - Stoff

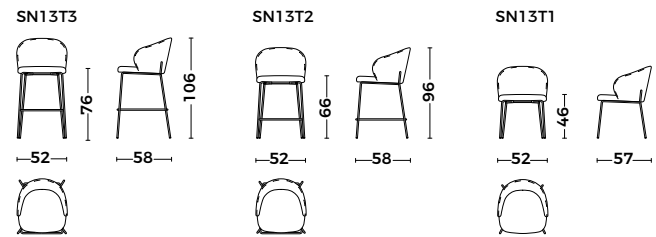

Pasha

ŠKOLJKA - lijevana pjena
 POSTOLJE - metal
 PRESVLAKA - tkanina
 SHELL - moulded foam
 BASE - metal
 UPHOLSTERY - fabric
 SCHALE - Gießschaum
 GESTELL - Metall
 BEZUG - Stoff

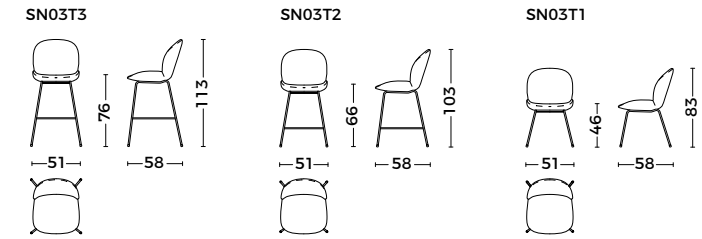

Miraz

ŠKOLJKA - lijevana pjena
 POSTOLJE - metal
 PRESVLAKA - tkanina
 SHELL - moulded foam
 BASE - metal
 UPHOLSTERY - fabric
 SCHALE - Gießschaum
 GESTELL - Metall
 BEZUG - Stoff

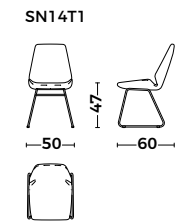

Uno

ŠKOLJKA - lijevana pjena
 POSTOLJE - aluminij
 PRESVLAKA - tkanina
 SHELL - moulded foam
 BASE - aluminij
 UPHOLSTERY - fabric
 SCHALE - Gießschaum
 GESTELL - Aluminium
 BEZUG - Stoff

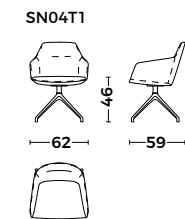

Uno Aria

ŠKOLJKA - lijevana pjena
 POSTOLJE - aluminij
 PRESVLAKA - tkanina
 SHELL - moulded foam
 BASE - aluminij
 UPHOLSTERY - fabric
 SCHALE - Gießschaum
 GESTELL - Aluminium
 BEZUG - Stoff

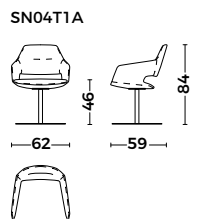

Bloom

ŠKOLJKA - lijevana pjena
 POSTOLJE - metal
 PRESVLAKA - tkanina
 SHELL - moulded foam
 BASE - metal
 UPHOLSTERY - fabric
 SCHALE - Gießschaum
 GESTELL - Metall
 BEZUG - Stoff

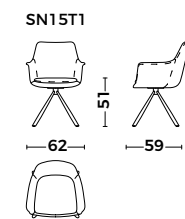

Lane

SJEDIŠTE I NASLON - lijevana pjena
 POSTOLJE - masiv
 PRESVLAKA - tkanina
 SEAT & BACKREST - moulded foam
 BASE - solid wood
 UPHOLSTERY - fabric
 SITZ UND RÜCKENLEHNE - Gießschaum
 GESTELL - Massivholz
 BEZUG - Stoff

SN16T1

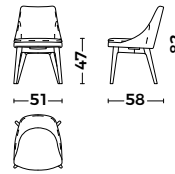

Laner

SJEDIŠTE I NASLON - lijevana pjena
 POSTOLJE - masiv
 PRESVLAKA - tkanina
 SEAT & BACKREST - moulded foam
 BASE - solid wood
 UPHOLSTERY - fabric
 SITZ UND RÜCKENLEHNE - Gießschaum
 GESTELL - Massivholz
 BEZUG - Stoff

SN17T1

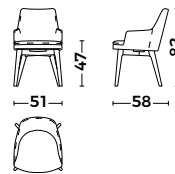

Rita / R

SJEDIŠTE I NASLON - lijevana pjena
 POSTOLJE - masiv
 PRESVLAKA - tkanina
 SEAT & BACKREST - moulded foam
 BASE - solid wood
 UPHOLSTERY - fabric
 SITZ UND RÜCKENLEHNE - Gießschaum
 GESTELL - Massivholz
 BEZUG - Stoff

SN18T1

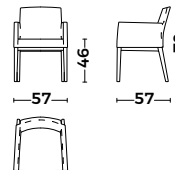

Alison

SJEDIŠTE I NASLON - furnir/HR spužva
 POSTOLJE - masiv
 PRESVLAKA - tkanina
 SHELL - veneer/HR foam
 BASE - solid wood
 UPHOLSTERY - fabric
 SCHALE - Furnier/HR-Schaum
 GESTELL - Massivholz
 BEZUG - Stoff

SN09T2

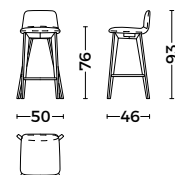

SN09T1

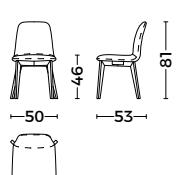

Sail

SJEDIŠTE I NASLON - metal/HR spužva
 POSTOLJE - masiv
 PRESVLAKA - tkanina
 SEAT & BACKREST - veneer/HR foam
 BASE - solid wood
 UPHOLSTERY - fabric
 SITZ UND RÜCKENLEHNE - Metall/HR-Schaum
 GESTELL - Massivholz
 BEZUG - Stoff

SN08T2

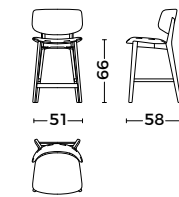

SN08T1

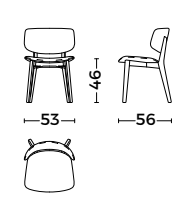

Duo/R

ŠKOLJKA - furnir/HR spužva
 POSTOLJE - masiv
 PRESVLAKA - tkanina
 SHELL - veneer/HR foam
 BASE - solid wood
 UPHOLSTERY - fabric
 SCHALE - Furnier/HR-Schaum
 GESTELL - Massivholz
 BEZUG - Stoff

SN10T2

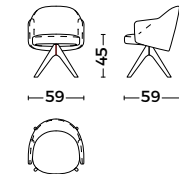

SN10T1

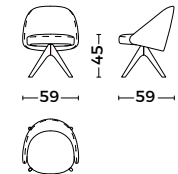

Prizma

SJEDIŠTE I NASLON - furnir/HR spužva
 POSTOLJE - masiv
 PRESVLAKA - tkanina
 BARSKA STOLICA - metalni obruč
 SEAT & BACKREST - veneer/HR foam
 BASE - solid wood
 UPHOLSTERY - fabric
 BAR STOOL - metal hoop
 SCHALE - Furnier/HR-Schaum
 GESTELL - Massivholz
 BEZUG - Stoff
 BAR STOOL - Metallreif

SN11T3

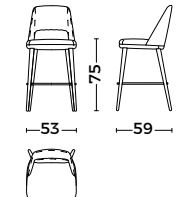

SN11T2

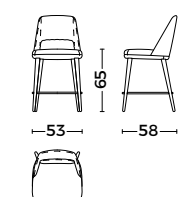

SN11T1

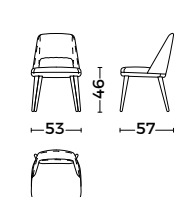

Indie

SJEDIŠTE I NASLON - lijevana pjena
 POSTOLJE - masiv
 PRESVLAKA - tkanina
 SEAT & BACKREST - moulded foam
 BASE - solid wood
 UPHOLSTERY - fabric
 SITZ UND RÜCKENLEHNE - Gießschaum
 GESTELL - Massivholz
 BEZUG - Stoff

SN19T1

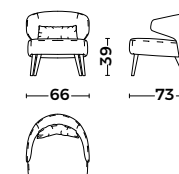

Fozy

GRADA - masiv/sperploča
 UNUTRAŠNJOŠT - bonelli jezgra
 SJEDIŠTE I NASLON - HRspužva/poliesterska vata
 POSTOLJE - masiv
 PRESVLAKA - tkanina

MATERIAL - solid wood/plywood
 SUSPENSION - bonelli core
 SEAT & BACKREST - HR foam/polyester wadding
 BASE - /solid wood
 UPHOLSTERY - fabric

STRUKTUR - Massivholz/Sperrholz
 FEDERUNG - Bonellfederkern/
 SITZ UND RÜCKENLEHNE - HR-Schaum/
 Polyesterwatte
 GESTELL - Massivholz
 BEZUG - Stoff

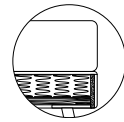

bonelli jezgra/bonelli core/
Bonellfederkern

SF01T2

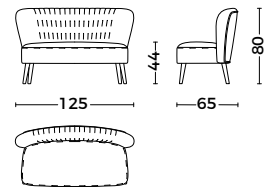

SF01T1

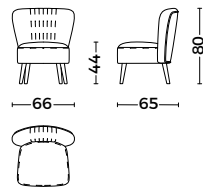

Frame

GRADA - masiv/iverica
 UNUTRAŠNJOŠT - elastična traka
 SJEDIŠTE I NASLON - HR spužva/poliesterska vata
 POSTOLJE - metal
 PRESVLAKA - tkanina

MATERIAL - solid wood/chipboard
 SUSPENSION - elastic straps
 SEAT & BACKREST - HR foam/polyester wadding
 BASE - metal
 UPHOLSTERY - fabric

STRUKTUR - Massivholz/Sperrholz
 FEDERUNG - elastische Bänder
 SITZ UND RÜCKENLEHNE - HR-Schaum/
 Polyesterwatte
 GESTELL - Massivholz
 BEZUG - Stoff

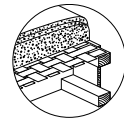

elastična traka/elastic straps/
elastische Bänder

SF02T2

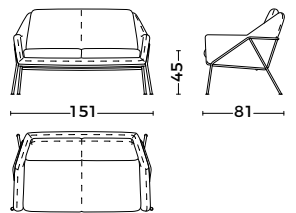

SF02T1

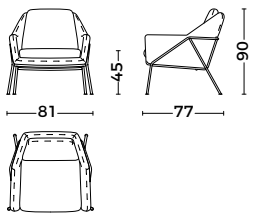

SF02T3

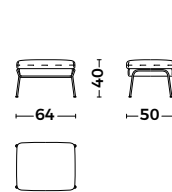

Regular

GRADA - masiv/sperploča/ iverica
 UNUTRAŠNJOŠT - elastična traka
 SJEDIŠTE I NASLON - HRspužva/poliesterska vata
 POSTOLJE - masiv
 PRESVLAKA - tkanina

MATERIAL - solid wood/plywood/chipboard
 SUSPENSION - elastic straps
 SEAT & BACKREST - HR foam/polyester wadding
 BASE - solid wood
 UPHOLSTERY - fabric

STRUKTUR - Massivholz/Sperrholz/ Spanplatte
 FEDERUNG - elastische Bänder
 SITZ UND RÜCKENLEHNE - HR-Schaum/
 Polyesterwatte
 GESTELL - Massivholz
 BEZUG - Stoff

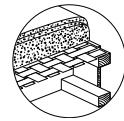

elastična traka/elastic straps/
elastische Bänder

SF03T1

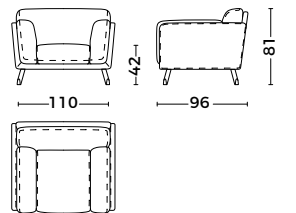

SF03T1 2

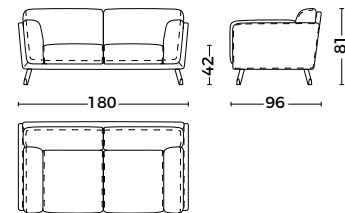

SF03T3

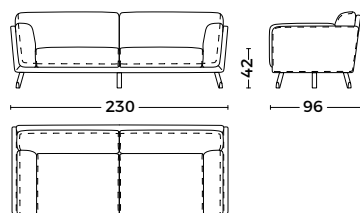

Softa

GRADA - masiv/sperploča/ iverica
 UNUTRAŠNJOŠT - elastična traka
 SJEDIŠTE I NASLON - HR spužva/poliesterska vata
 POSTOLJE - masiv
 PRESVLAKA - tkanina

MATERIAL - solid wood/plywood/chipboard
 SUSPENSION - elastic straps
 SEAT & BACKREST - HR foam/polyester wadding
 BASE - solid wood
 UPHOLSTERY - fabric

STRUKTUR - Massivholz/Sperrholz/ Spanplatte
 FEDERUNG - elastische Bänder
 SITZ UND RÜCKENLEHNE - HR-Schaum/
 Polyesterwatte
 GESTELL - Massivholz
 BEZUG - Stoff

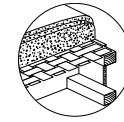

elastična traka/elastic straps/
elastische Bänder

SF04T8L / SF04T8R

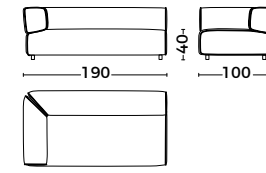

SF04T5L / SF04T5R

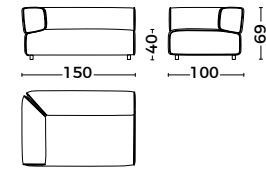

SF04T6L / SF04T6R

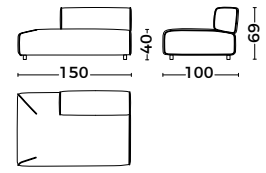

SF04T2

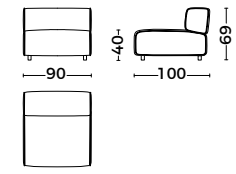

SF04T4

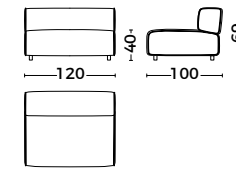

SF04T3

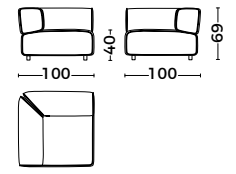

SF04T7L / SF04T7R

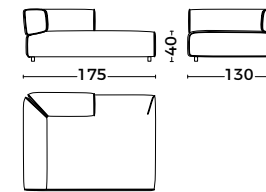

SF04T1

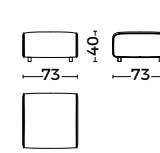

SF04T12

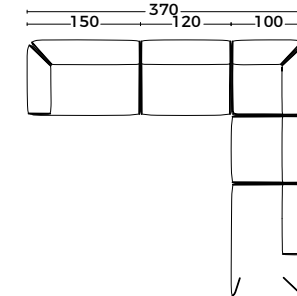

SF04T11

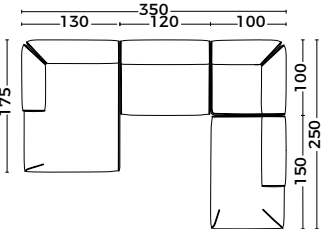

SF04T10

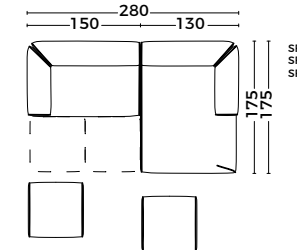

SF04T9

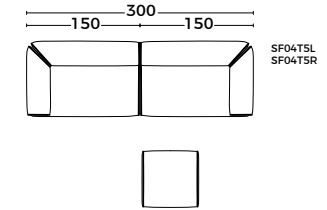

Stretch

GRADA - masiv/šperploča/ iverica
 UNUTRAŠNOST - elastična traka
 SJEDIŠTE I NASLON - HR spužva/poliesterska vata
 POSTOLJE - masiv
 PRESVLAKA - tkanina

MATERIAL - solid wood/plywood/chipboard
 SUSPENSION - elastic straps
 SEAT & BACKREST - HR foam/polyester wadding
 BASE - solid wood
 UPHOLSTERY - fabric

STRUKTUR - Massivholz/Sperrholz/ Spanplatte
 FEDERUNG - elastische Bänder
 SITZ UND RÜCKENLEHNE - HR-Schaum/
 Polyesterwatte
 GESTELL - Massivholz
 BEZUG - Stoff

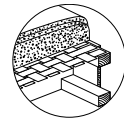

elastična traka/elastic straps/
 elastische Bänder

SF05T6L / SF05T6R

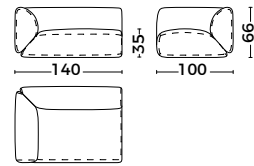

SF05T7L / SF05T7R

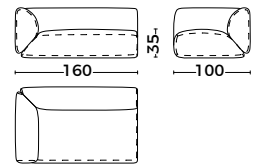

SF05T3

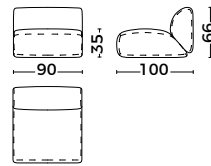

SF05T5

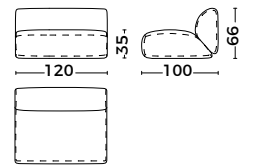

SF05T4

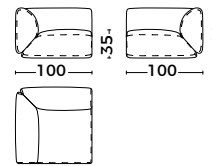

SF05T1

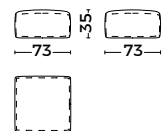

SF05T2

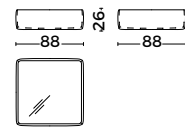

SF05T12

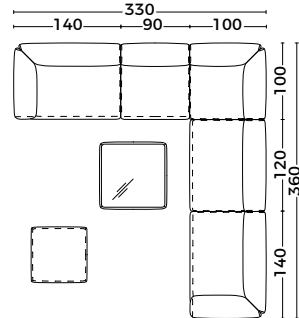

SF05T11

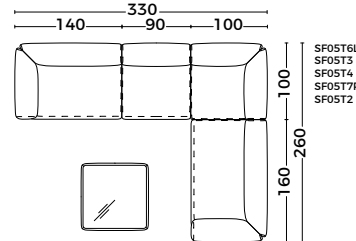

SF05T9

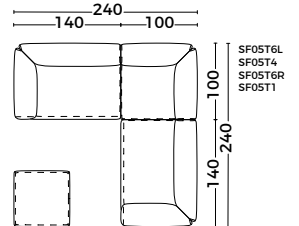

SF05T8

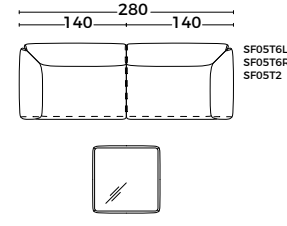

Paris

GRADA - masiv/iverica
 UNUTRAŠNOST - val opruge
 SJEDIŠTE I NASLON - HR spužva/poliesterska vata
 POSTOLJE - metal
 PRESVLAKA - tkanina

MATERIAL - solid wood/chipboard
 SUSPENSION - wave springs
 SEAT & BACKREST - HR foam/polyester wadding
 BASE - metal
 UPHOLSTERY - fabric

STRUKTUR - Massivholz/Spanplatte
 FEDERUNG - Wellenfeder
 SITZ UND RÜCKENLEHNE - HR-Schaum/
 Polyesterwatte
 GESTELL - Metall
 BEZUG - Stoff

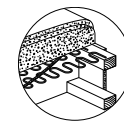

val opruge/wave springs/
 Wellenfeder

SF06T3

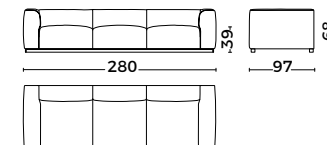

SF06T4L / SF06T4R

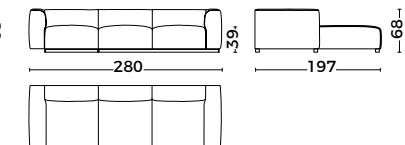

SF06T2

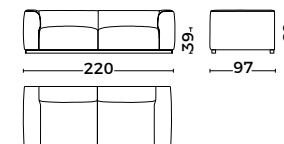

SF06T1

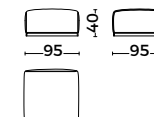

Roma

GRADA - masiv/iverica
 UNUTRAŠNOST - elastična traka
 SJEDIŠTE I NASLON - HR spužva/poliesterska vata
 POSTOLJE - metal
 PRESVLAKA - tkanina

MATERIAL - solid wood/chipboard
 SUSPENSION - elastic straps
 SEAT & BACKREST - HR foam/polyester wadding
 BASE - metal
 UPHOLSTERY - fabric

STRUKTUR - Massivholz/Spanplatte
 FEDERUNG - elastische Bänder
 SITZ UND RÜCKENLEHNE - HR-Schaum/
 Polyesterwatte
 GESTELL - Metall
 BEZUG - Stoff

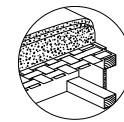

elastična traka/elastic straps/
 elastische Bänder

SF07T3

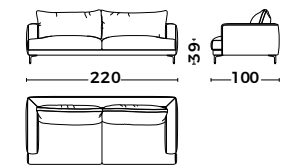

SF07T2

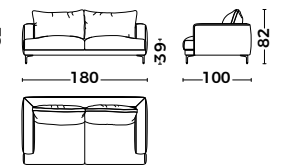

SF07T1

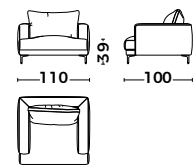

SF07T6L / SF07T6R

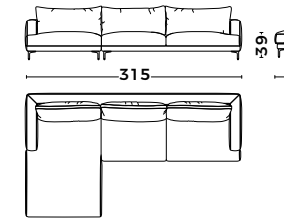

SF07T5L / SF07T5R

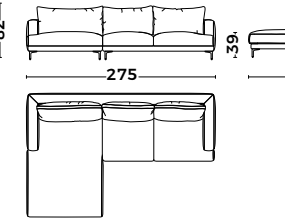

SF07T4

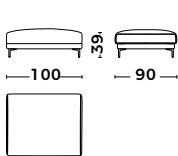

Cubic

GRADA - masiv/iverica
 UNUTRAŠNOST - elastična traka
 SJEDIŠTE - HR spužva
 PRESVLAKA - tkanina

MATERIAL - solid wood/chipboard
 SUSPENSION - elastic straps
 SEAT - HR foam
 UPHOLSTERY - fabric

STRUKTUR - Massivholz/ Spanplatte
 FEDERUNG - elastische Bänder
 SITZ - HR-Schaum
 BEZUG - Stoff

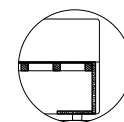

HR spužva/HR foam/
 HR-Schaum

SF11T1

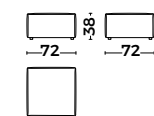

SF11T2

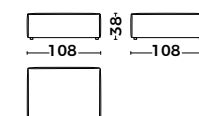

SF11T3

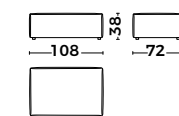

SF11T4

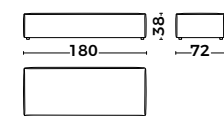

SF11T5

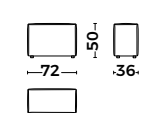

SF11T6

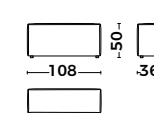

SF11T7

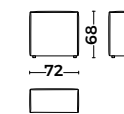

SF11T8

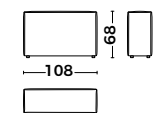

Valencia

GRADA - masiv/iverica
 UNUTRAŠNJOŠT - val opruge
 SEDIŠTE I NASLON - HR spužva/poliesterska vata
 POSTOLJE - masiv
 PRESVLAKA - tkanina

MATERIAL - solid wood/chipboard
 SUSPENSION - wave springs
 SEAT & BACKREST - HR foam/polyester wadding
 BASE - solid wood
 UPHOLSTERY - fabric

STRUKTUR - Massivholz/Spanplatte
 FEDERUNG - Wellenfeder
 SITZ UND RÜCKENLEHNE - HR-Schaum/
 Polyesterwatte
 GESTELL - Massivholz
 BEZUG - Stoff

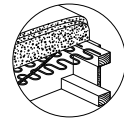

val opruge/wave springs/
 Wellenfeder

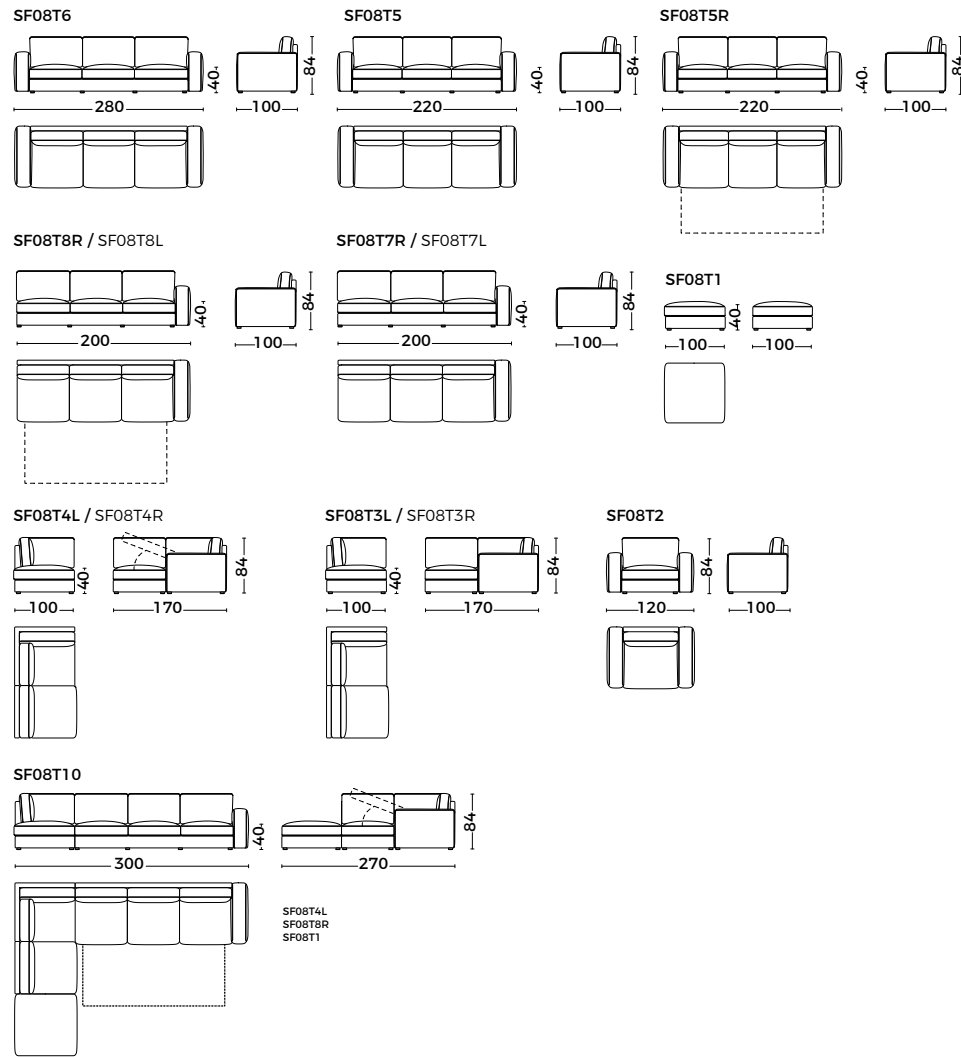

Manhattan

GRADA - masiv/iverica
 UNUTRAŠNJOŠT - val opruge
 SEDIŠTE I NASLON - HR spužva/poliesterska vata
 POSTOLJE - metal
 PRESVLAKA - tkanina

MATERIAL - solid wood/chipboard
 SUSPENSION - wave springs
 SEAT & BACKREST - HR foam/polyester wadding
 BASE - metal
 UPHOLSTERY - fabric

STRUKTUR - Massivholz/Spanplatte
 FEDERUNG - Wellenfeder
 SITZ UND RÜCKENLEHNE - HR-Schaum/
 Polyesterwatte
 GESTELL - Metall
 BEZUG - Stoff

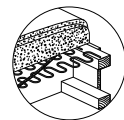

val opruge/wave springs/
 Wellenfeder

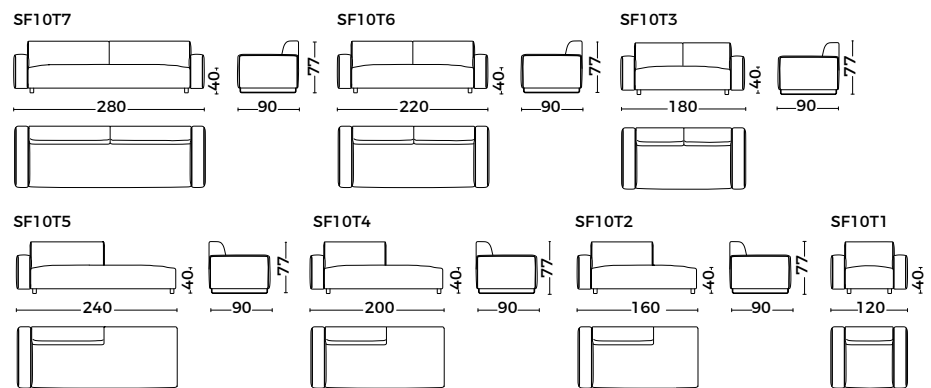

Linea

UZGLAVLJE - iverica/HR spužva
 KREKET - masiv/iverica/HR spužva/podnica
 PRESVLAKA - tkanina
 POSTOLJE - masiv

HEADBOARD - chipboard/HR foam
 BED - solid wood/chipboard/HR foam/bed slats
 UPHOLSTERY - fabric
 BASE - solid wood

KOPFENDE - Spanplatte/HR-Schaum
 BETT - Massivholz/Spanplatte/HR-Schaum/
 Bettboden
 BEZUG - Stoff
 GESTELL - Massivholz

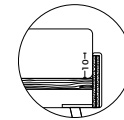

podnica/bed floor/
 Bettboden

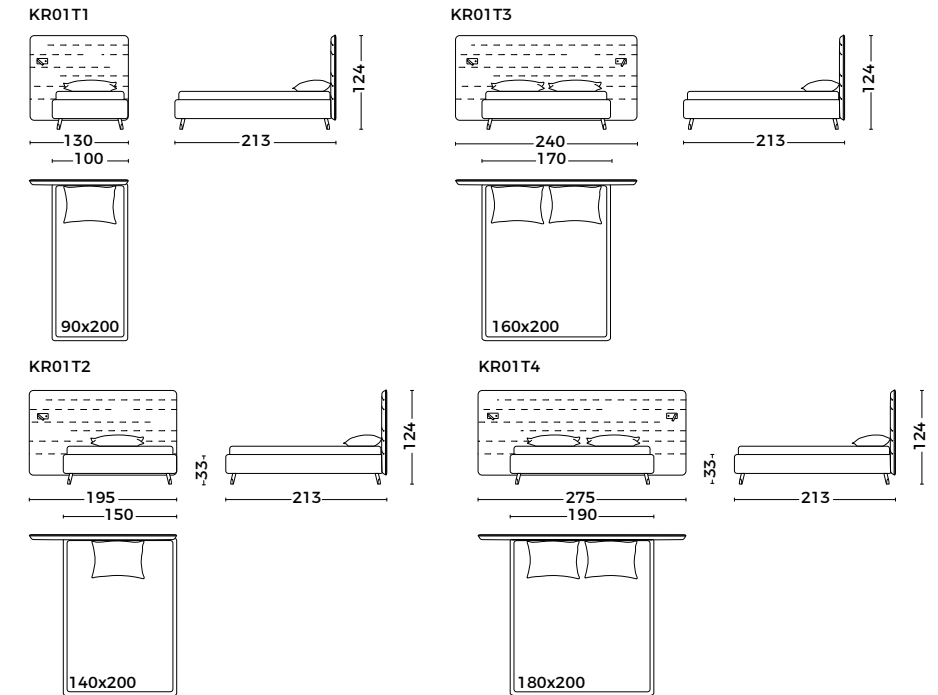

Domino

UZGLAVLJE - iverica/HR spužva
 KREKET - masiv/iverica/HR spužva/podnica
 PRESVLAKA - tkanina
 POSTOLJE - masiv

HEADBOARD - chipboard/HR foam
 BED - solid wood/chipboard/HR foam/bed slats
 UPHOLSTERY - fabric
 BASE - solid wood

KOPFENDE - Spanplatte/HR-Schaum
 BETT - Massivholz/Spanplatte/HR-Schaum/
 Bettboden
 BEZUG - Stoff
 GESTELL - Massivholz

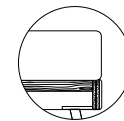

podnica/bed floor/
 Bettboden

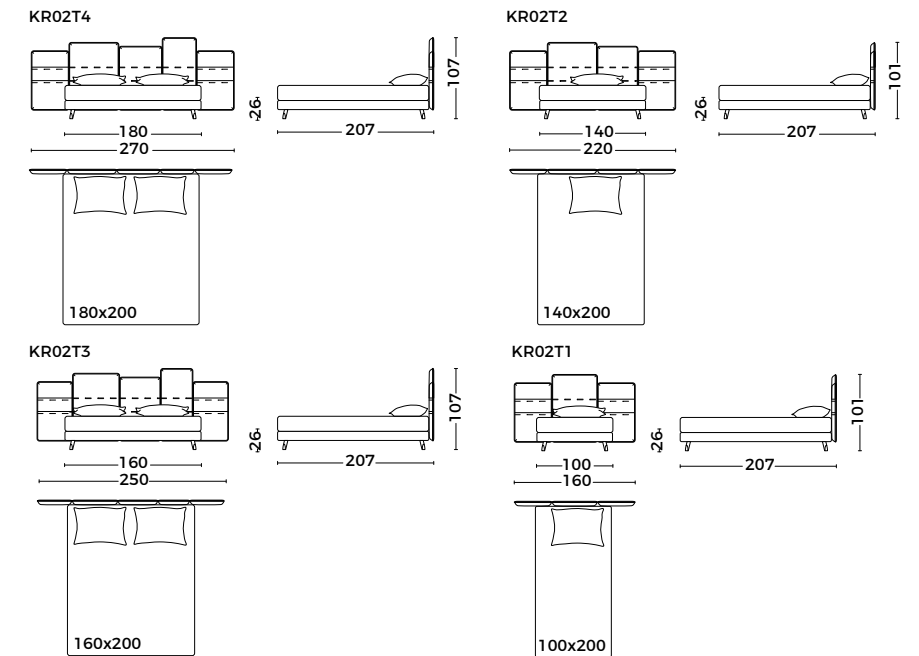

Ares

UZGLAVLJE - iverica/masiv
 KREVET - masiv/iverica/HR spužva/podnica
 PRESVLAKA - tkanina
 POSTOLJE - metal
 HEADBOARD - chipboard/solid wood
 BED - solid wood/chipboard/HR foam/bed slats
 UPHOLSTERY - fabric
 BASE - metal
 KOPFENDE - Spanplatte/Massivholz
 BETT - Massivholz/Spanplatte/HR-Schaum/
 Bettboden
 BEZUG - Stoff
 GESTELL - Metall

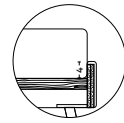

podnica/bed floor/
Bettboden

KR03T4

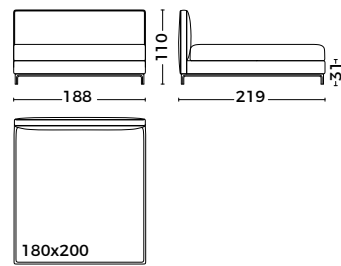

KR03T3

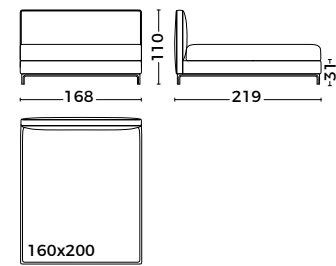

KR03T2

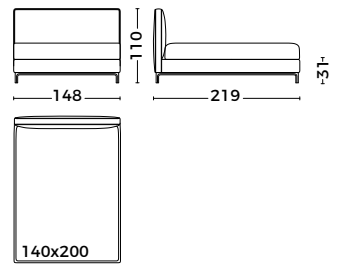

KR03T1

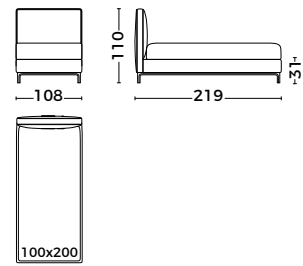

Virgo

UZGLAVLJE - iverica/masiv
 KREVET - masiv/iverica/HR spužva/podnica
 PRESVLAKA - tkanina
 POSTOLJE - metal
 HEADBOARD - chipboard/solid wood
 BED - solid wood/chipboard/HR foam/bed slats
 UPHOLSTERY - fabric
 BASE - metal
 KOPFENDE - Spanplatte/Massivholz
 BETT - Massivholz/Spanplatte/HR-Schaum/
 Bettboden
 BEZUG - Stoff
 GESTELL - Metall

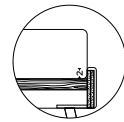

podnica/bed floor/
Bettboden

KR04T4

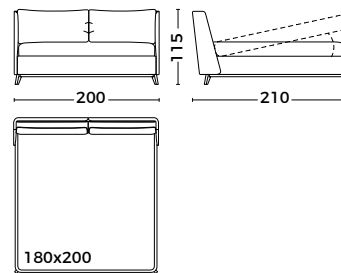

KR04T3

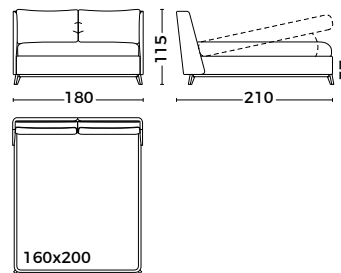

KR04T2

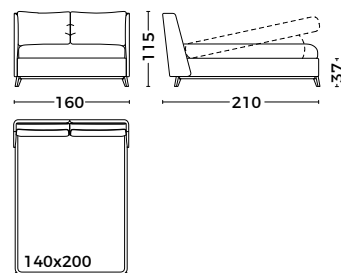

KR04T1

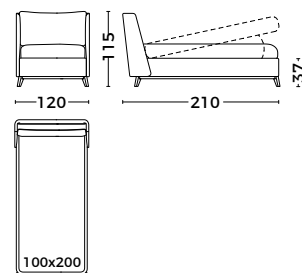

Cozy

UZGLAVLJE - iverica/HR spužva/poliesterska vata
 KREVET - masiv/iverica/HR spužva/podnica/bonell jezgra
 PRESVLAKA - tkanina
 POSTOLJE - masiv/plastika
 HEADBOARD - chipboard/HR foam/polyester wadding
 BED - solid wood/chipboard/HR foam/bed slats/
 bonell spring core
 UPHOLSTERY - fabric
 BASE - solid wood/plastic
 KOPFENDE - Spanplatte/HR-Schaum/
 Polyesterwatte
 BETT - Massivholz/Spanplatte/HR-Schaum/Bettboden
 BEZUG - Stoff
 GESTELL - Massivholz

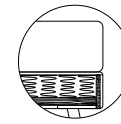

bonell jezgra/bonell core/
Bonellfederkern



set nogica/sets of legs/ Sätze
von Beinen



dodatak/accessories/
accessories

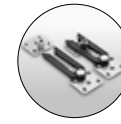

dodatak/accessories/
accessories

KR05T1 / KR05T2

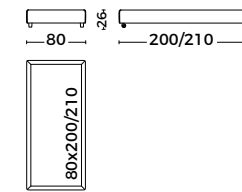

KR05T3 / KR05T4

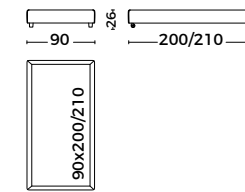

KR05T5 / KR05T6

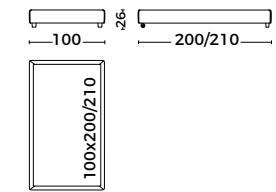

KR05T7 / KR05T8

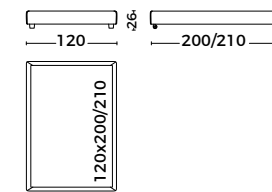

KR05T9 / KR05T10

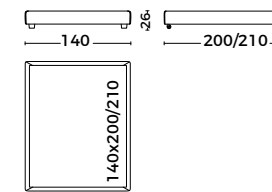

KR05T11 / KR05T12

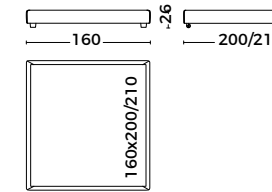

KR05T13 / KR05T14

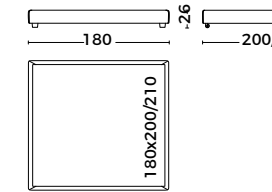

KR05U80

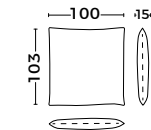

KR05U90

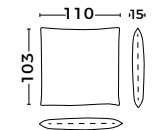

KR05U100

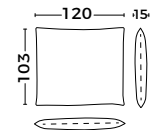

KR05120

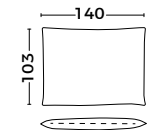

KR05U140

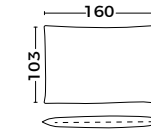

KR05U160

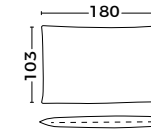

KR05U180

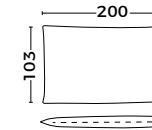

Leaf

UZGLAVLJE - masiv/HR spužva
 KREVET - masiv/iverica/HR spužva
 PRESVLAKA - tkanina
 HEADBOARD - solid wood/HR foam
 BED - solid wood/chipboard/HR foam
 UPHOLSTERY - fabric
 KOPFENDE - Massivholz/HR-Schaum
 BETT - Massivholz/Spanplatte/HR-Schaum
 BEZUG - Stoff

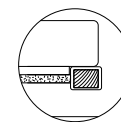

HR spužva/HR foam/
HR-Schaum

KR06T2

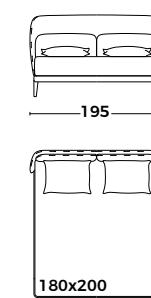

KR06T1



Linea Art

UZGLAVLJE - masiv/ HR spužva/
KREVET - masiv/iverica/HR spužva/podnica
PRESVLAKA - tkanina

HEADBOARD - solid wood/HR foam
BED - solid wood/chipboard/HR foam/bed slats
UPHOLSTERY - fabric

KOPFENDE - Massivholz/ HR-Schaum
BETT - Massivholz/Spanplatte/HR-Schaum/Bettboden
BEZUG - Stoff

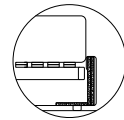

HR spužva/HR foam/
HR-Schaum

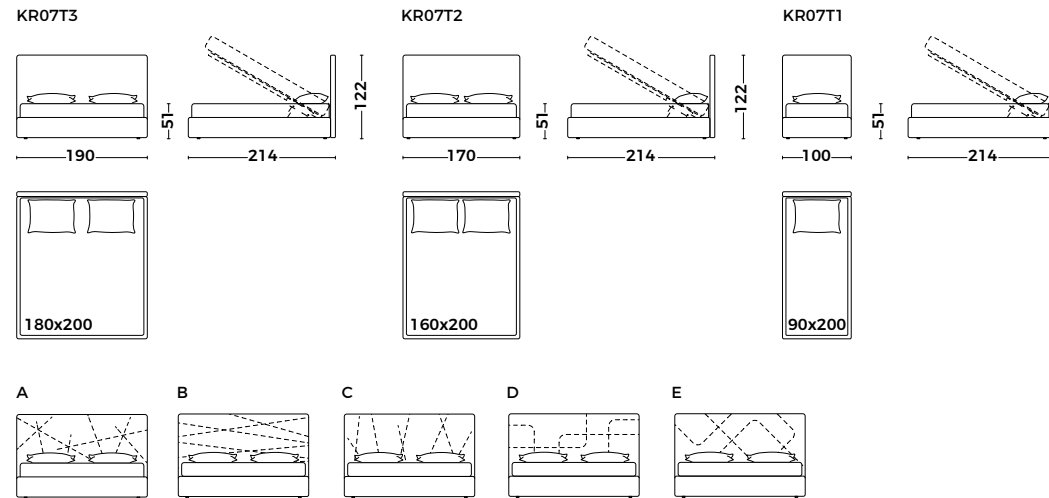

Stretchbed

UZGLAVLJE - masiv/ HR spužva
KREVET - masiv/iverica/HR spužva/podnica
PRESVLAKA - tkanina

HEADBOARD - solid wood/HR foam
BED - solid wood/chipboard/HR foam/bed slats
UPHOLSTERY - fabric

KOPFENDE - Spanplatte/Massivholz/ HR-Schaum
BETT - Massivholz/Spanplatte/HR-Schaum/Bettboden
BEZUG - Stoff

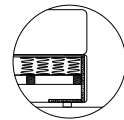

bonell jezgra/bonell core/
Bonellfederkern

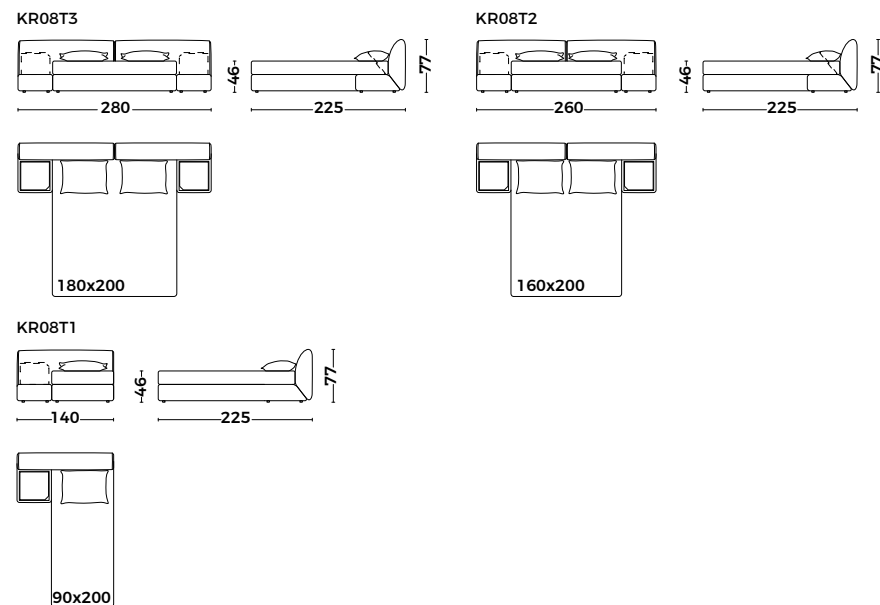

Oval

PLOČA STOLA - lakirani MDF
POSTOLJE - plastificirani metal

TABLETOP - lacquered MDF
BASE - powder coated metal

TISCHPLATTE - lackierte MDF-Platte
GESTELL - plastifiziertes Metall

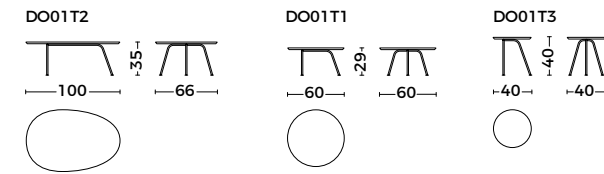

Meshroom

PLOČA STOLA - lakirani MDF/furnir
POSTOLJE - plastificirani metal

TABLETOP - lacquered MDF/veneer
BASE - powder coated metal

TISCHPLATTE - lackierte MDF-Platte/ Furnier
GESTELL - plastifiziertes Metall

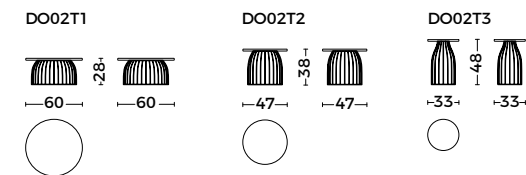

Poker

PLOČA STOLA - lakirani MDF
POSTOLJE - plastificirani metal

TABLETOP - lacquered MDF
BASE - powder coated metal

TISCHPLATTE - lackierte MDF-Platte
GESTELL - plastifiziertes Metall

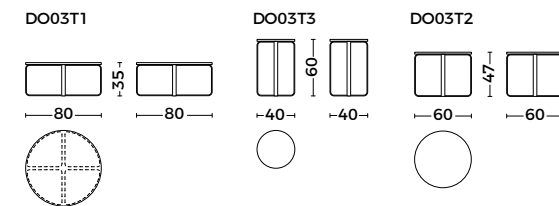

Poker tabure

GRADA - masiv/iverica
UNUTRAŠNJOŠT - elastična traka/HR spužva/
poliesterka vata
POSTOLJE - plastika
PRESVLAKA - tkanina

MATERIAL - solid wood/chipboard
SUSPENSION - elastic straps/HR foam/polyester
wadding
BASE - plastic
UPHOLSTERY - fabric

STRUKTUR - Massivholz/Spanplatte
FEDERUNG - elastische Bänder/HR-Schaum/
Polyesterwatte
GESTELL - Kunststoff
BEZUG - Stoff

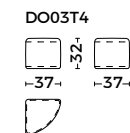

Bassic

PLOČA STOLA - lakirani MDF
 POSTOLJE - lakirani beton
 TABLE TOP - lacquered MDF
 BASE - lacquered concrete
 TISCHPLATTE - lackierte MDF-Platte
 GESTELL - lackierter Beton

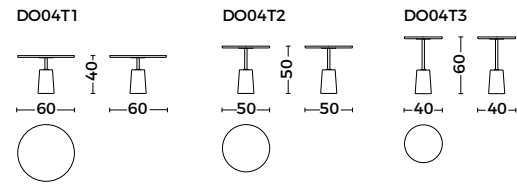

Mila

PLOČA STOLA - plastificirani metal
 POSTOLJE - plastificirani metal
 TABLE TOP - plasticized metal
 BASE - powder coated metal
 TISCHPLATTE - plastifiziertes Metall
 GESTELL - plastifiziertes Metall

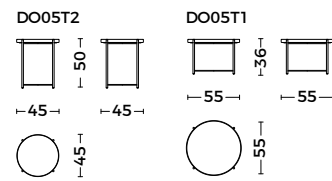

Quadro

PLOČA STOLA - lakirani MDF/furnir
 POSTOLJE - plastificirani metal
 TABLE TOP - lacquered MDF/veneer
 BASE - powder coated metal
 TISCHPLATTE - lackierte MDF-Platte/ Furnier
 GESTELL - plastifiziertes Metall

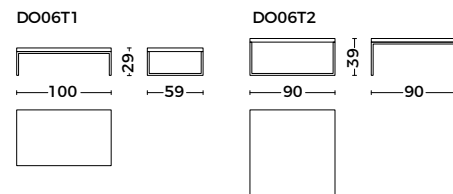

Pascale

PLOČA STOLA - lakirani MDF/furnir
 POSTOLJE - plastificirani metal
 TABLE TOP - lacquered MDF/veneer
 BASE - powder coated metal
 TISCHPLATTE - lackierte MDF-Platte/ Furnier
 GESTELL - plastifiziertes Metall

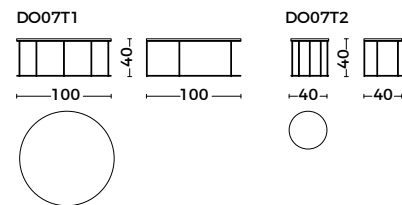

Teka / Ø

PLOČA STOLA - furnir
 POSTOLJE - masiv
 TABLE TOP - veneer
 BASE - solid wood
 TISCHPLATTE - Furnier
 GESTELL - Massivholz

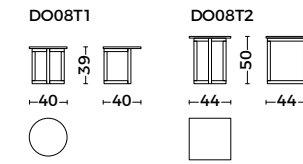

Island

PLOČA STOLA - lakirani MDF/furnir
 POSTOLJE - plastificirani metal
 TABLE TOP - lacquered MDF/veneer
 BASE - powder coated metal
 TISCHPLATTE - lackierte MDF-Platte/ Furnier
 GESTELL - plastifiziertes Metall

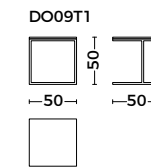

Unotab

PLOČA STOLA - lakirani MDF
 POSTOLJE - metal
 TABLETOP - lacquered MDF
 BASE - metal
 TISCHPLATTE - lackierte MDF-Platte
 GESTELL - metall

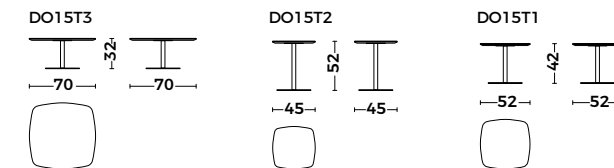

Aruba

GRADA - masiv/iverica
 UNUTRAŠNOST - elastična traka/HR spužva/
 poliesterska vata
 POSTOLJE - MDF
 PRESVLAKA - tkanina
 MATERIAL - solid wood/chipboard
 SUSPENSION - elastic straps/HR foam/
 polyester wadding
 BASE - MDF
 UPHOLSTERY - fabric
 STRUKTUR - Massivholz/Spanplatte
 FEDERUNG - elastische Bänder/HR-Schaum/
 Polyesterwatte
 GESTELL - MDF-Platte
 BEZUG - Stoff

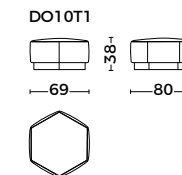

Capri / Ø

GRADA - masiv/iverica
UNUTRAŠNJOŠT - elastična traka/HR spužva/
poliesterska vata
POSTOLJE - plastika
PRESVLAKA - tkanina

MATERIAL - solid wood/chipboard
SUSPENSION - elastic straps/HR foam/polyester
wadding
BASE - plastic
UPHOLSTERY - fabric

STRUKTUR - Massivholz/Spanplatte
FEDERUNG - elastische Bänder/HR-Schaum/Poly-
esterwatte
GESTELL - Kunststoff
BEZUG - Stoff

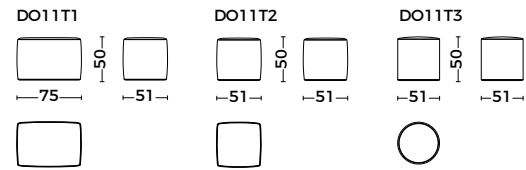

Isla

GRADA - masiv/iverica
UNUTRAŠNJOŠT - elastična traka/HR spužva/
poliesterska vata
POSTOLJE - masiv
PRESVLAKA - tkanina

MATERIAL - solid wood/chipboard
SUSPENSION - elastic straps/HR foam/polyester
wadding
BASE - solid wood
UPHOLSTERY - fabric

STRUKTUR - Massivholz/Spanplatte
FEDERUNG - elastische Bänder/HR-Schaum/
Polyesterwatte
GESTELL - Massivholz
BEZUG - Stoff

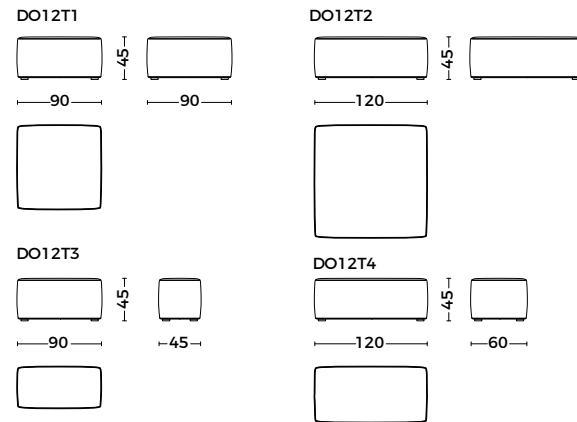

Martin

GRADA - masiv/iverica
UNUTRAŠNJOŠT - elastična traka/HR spužva/
poliesterska vata
POSTOLJE - plastika
PRESVLAKA - tkanina

MATERIAL - solid wood/chipboard
SUSPENSION - elastic straps/HR foam/polyester
wadding
BASE - plastic
UPHOLSTERY - fabric

STRUKTUR - Massivholz/Spanplatte
FEDERUNG - elastische Bänder/HR-Schaum/
Polyesterwatte
GESTELL - Kunststoff
BEZUG - Stoff

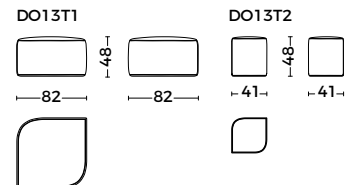

Dali

GRADA - masiv/iverica
UNUTRAŠNJOŠT - elastična traka/HR spužva/
poliesterska vata
POSTOLJE - metal
PRESVLAKA - tkanina

MATERIAL - solid wood/chipboard
SUSPENSION - elastic straps/HR foam/polyester
wadding
BASE - Metal
UPHOLSTERY - fabric

STRUKTUR - Massivholz/Spanplatte
FEDERUNG - elastische Bänder/HR-Schaum/
Polyesterwatte
GESTELL - Metall
BEZUG - Stoff

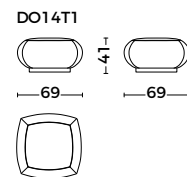

LET US GO



Kolekcija boja / color collection / farbsammlung

MDF



RAL 7040

RAL 7016

RAL 9011

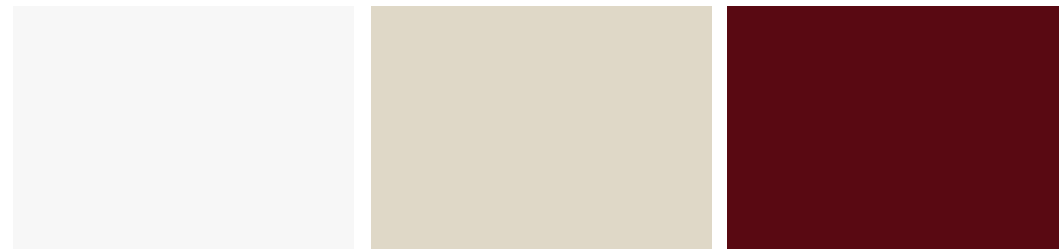

RAL 9003

RAL 1013

RAL 3005



RAL 6034

RAL 5024

RAL 5003



RAL 6021

RAL 3015

RAL 2001

Kolekcija boja / color collection / farbsammlung

Solid wood - beech / oak



BEECH NATUR

OAK NATUR

BEECH 1

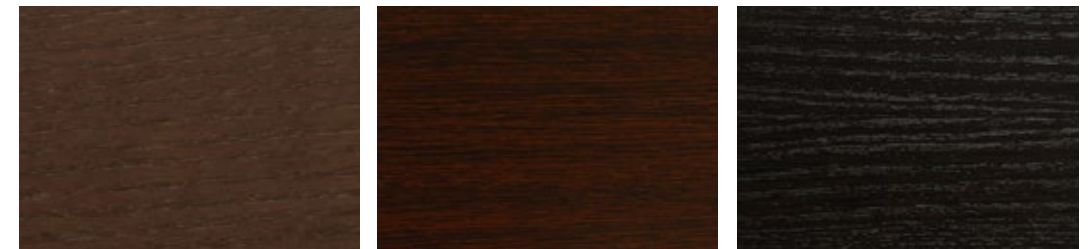

BEECH 19

BEECH 24

BEECH 29

Metal



RAL 7040

RAL 7016

RAL 9011



RAL 9003

RAL 2001



* PRICE LIST

Tkanine i koža / fabric and leather / stoffe und leder

Kabal

Kategorija a / category a / kategorie a



9244

9534

9611



9591

9844

9934



9426

9180

9502



9200

9573

7006

Tkanine i koža / fabric and leather / stoffe und leder

Tiago

Kategorija a / category a / kategorie a



3906

3315

9110

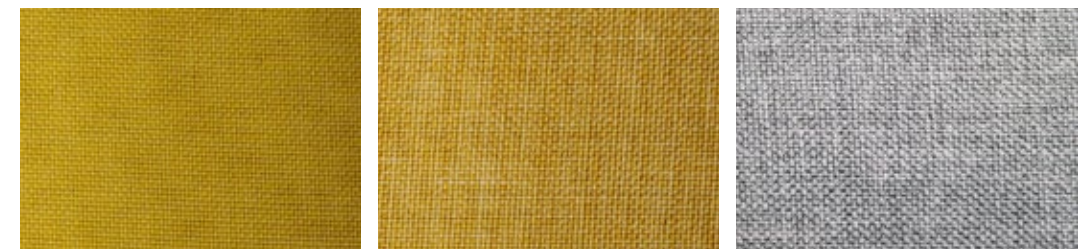

9848

5569

9905



9636

6110

5246

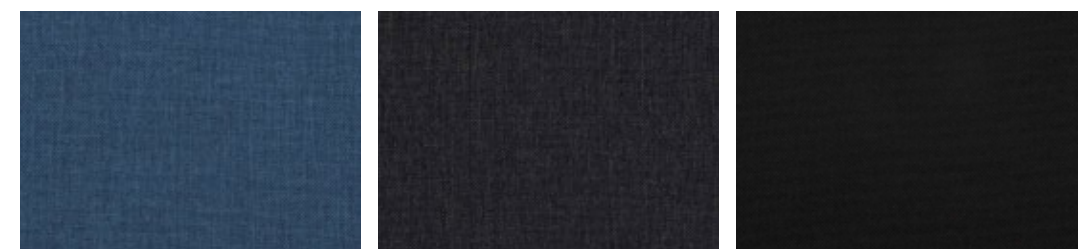

9324

5454

7006

Tkanine i koža / fabric and leather / stoffe und leder

Bombay

Kategorija a / category a / kategorie a



04

14

24



39

57

69



26

38

63

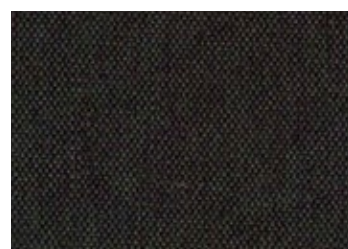

56

Tkanine i koža / fabric and leather / stoffe und leder

Burkley

Kategorija a / category a / kategorie a

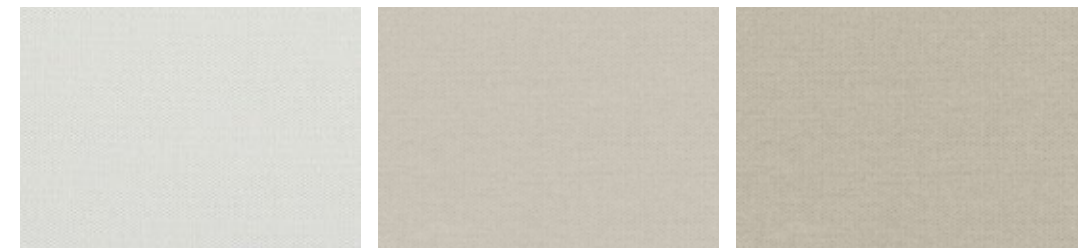

9106

9534

9603

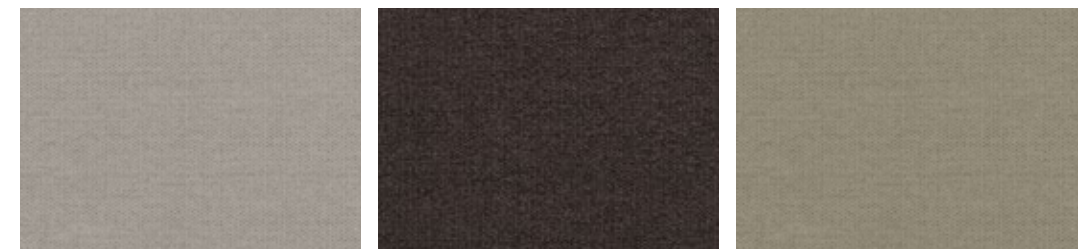

9120

9591

9013



9330

9402

9410

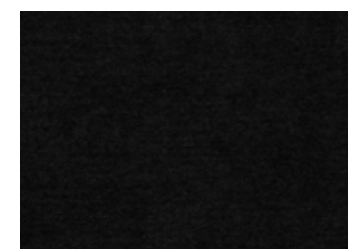

9700

Tkanine i koža / fabric and leather / stoffe und leder

Dublin

Kategorija a / category a / kategorie a



04

44

33



25

37

48



26

16

36



56

Tkanine i koža / fabric and leather / stoffe und leder

Mexico

Kategorija a / category a / kategorie a

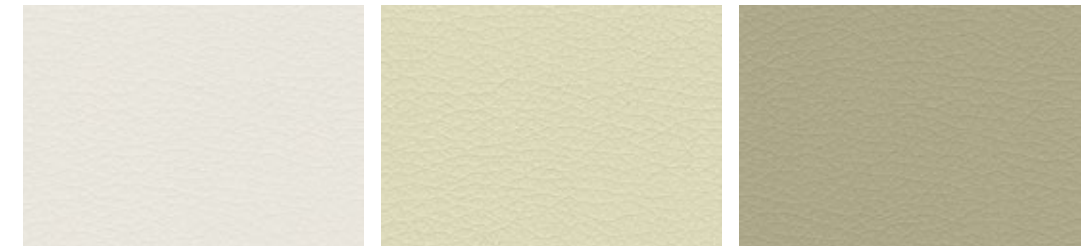

01

14

24



34

89

64



06

26

56



02

Tkanine i koža / fabric and leather / stoffe und leder

Amsterdam

Kategorija b / category b / kategorie b

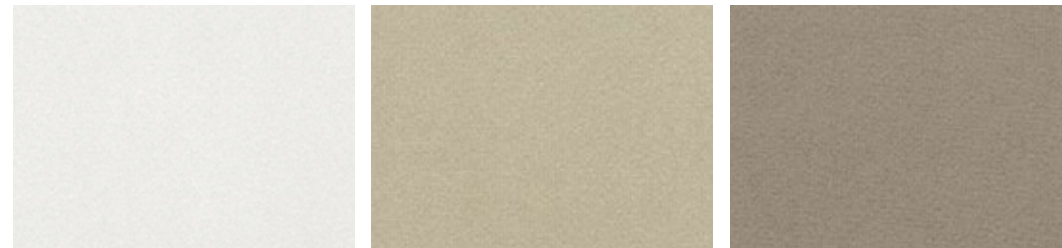

01

14

44

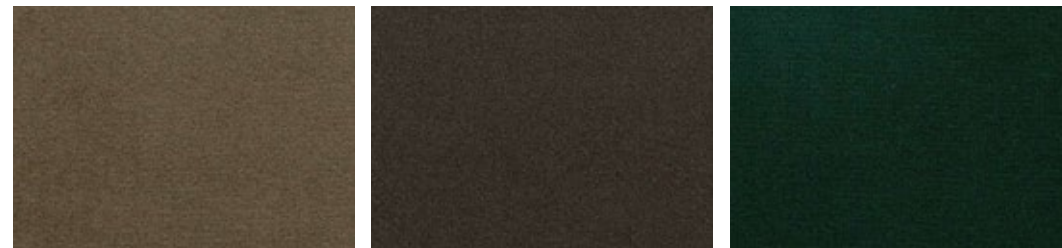

54

84

48

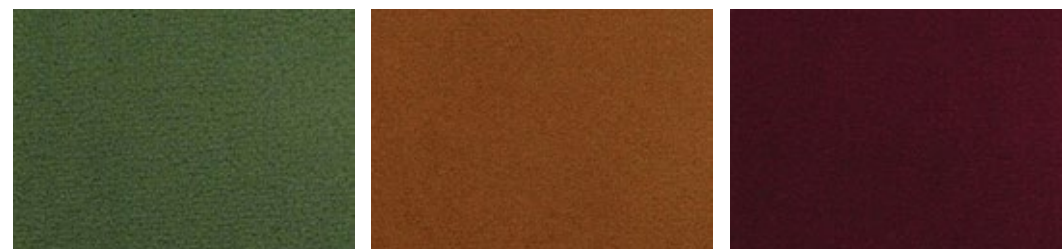

38

49

63



47

57

17



03

58

46

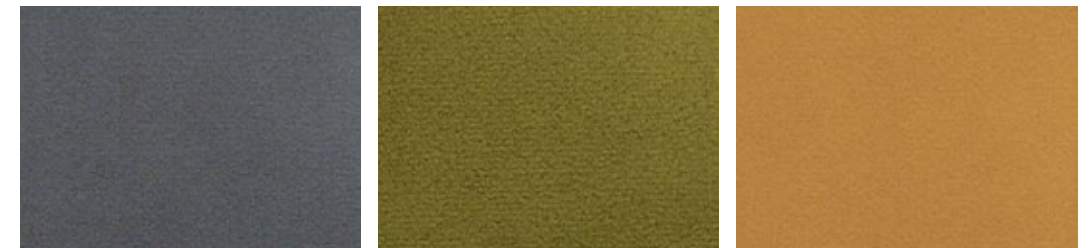

66

135

105

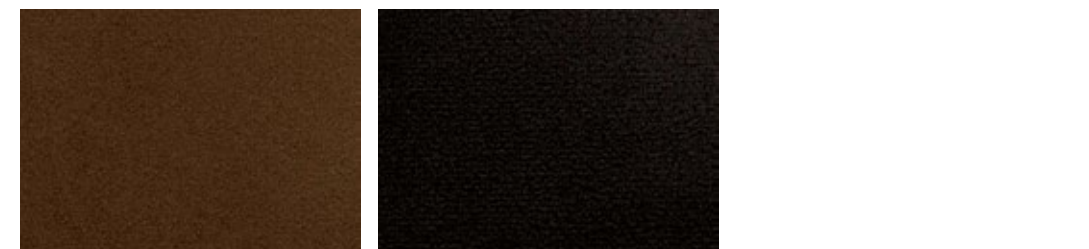

154

176

Tkanine i koža / fabric and leather / stoffe und leder

Bianca

Kategorija c / category c / kategorie c



16

12

10

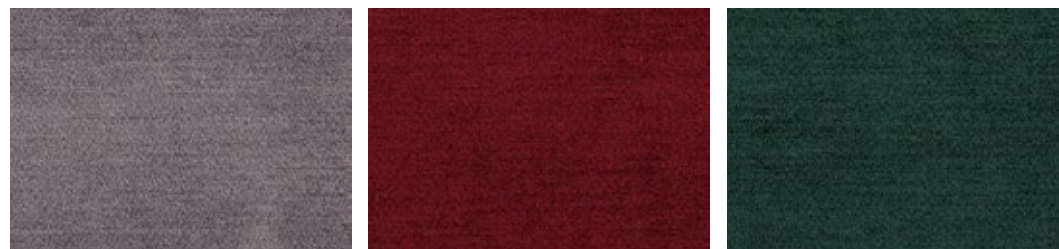

28

22

37



19

02

30



04

Tkanine i koža / fabric and leather / stoffe und leder

Mystic

Kategorija c / category c / kategorie c

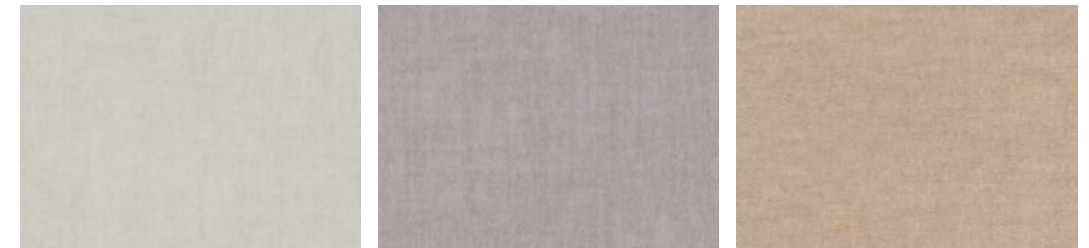

324

32

03

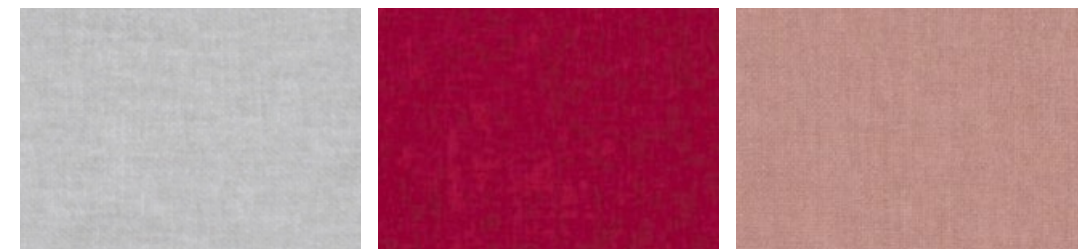

250

66

503

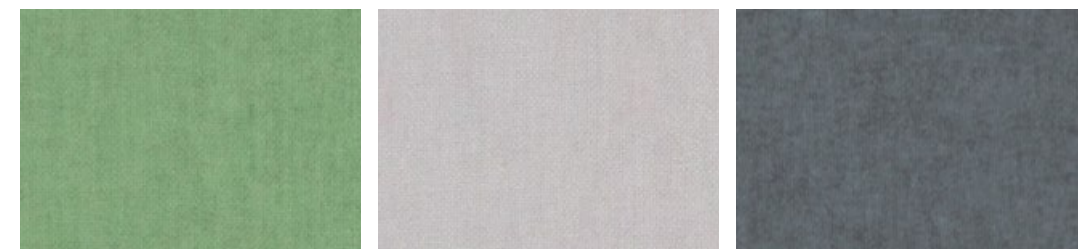

387

136

213

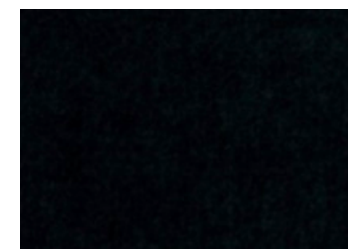

59

EM Möbel Deign GmbH
Donaustraße 2
94469 Deggendorf

Tel.: +49 1520 6294374
E-Mail: info@emmoebel.com